



LIGITEK ELECTRONICS CO.,LTD.
Property of Ligitek Only

SURFACE MOUNT LED TAPE AND REEL



Lead-Free Parts

LHY9553R/TR1-RG-B01

DATA SHEET

DOC. NO : QW0905-LHY9553R/TR1-RG-B01

REV. : C

DATE : 22 - Nov. - 2017



Features:

1. Top view LED.
2. white SMT package.
3. Leadframe package with individual 2 pin.
4. Wide viewing angle.
5. Soldering methods: IR reflow soldering.
6. Feature of the device: more light due to higher optical efficiency; extremely wide viewing angle; ideal for backlighting and coupling in light guide.

Descriptions:

The LHY9553R SMD has wide viewing angle and optimized light coupling by inter reflector, The low current requirement makes this device ideal for portable equipment or any other application where power is at a premium.

Applications:

1. Telecommunication: indicator and backlighting in telephone and fax.
2. Indicators.
3. Switch lights.

Device Selection Guide:

PART NO	MATERIAL	COLOR	
		Emitted	Lens
LHY9553R/TR1-RG-B01	AlGaInP	Yellow	Water Clear

Package Dimensions

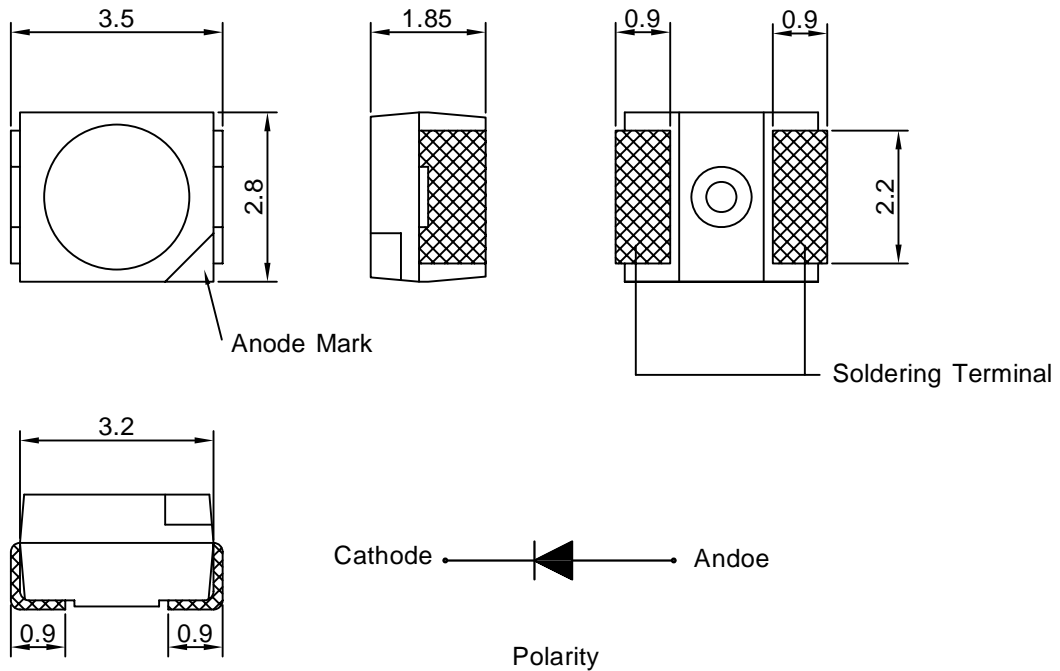

Note : 1.All dimension are in millimeter tolerance is $\pm 0.2\text{mm}$ unless otherwise noted.
 2.Specifications are subject to change without notice.

Recommended Soldering Pad Dimensions

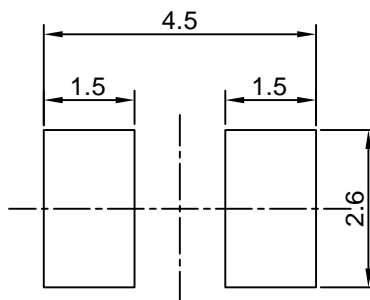

Note : The tolerances unless mentioned is $\pm 0.1\text{mm}$, Angle ± 0.5 . Unit=mm.

Absolute Maximum Ratings at Ta=25°C

Parameter	Symbol	Ratings	UNIT
		HY(R)	
Forward Current	I _F	30	mA
Peak Forward Current Duty 1/10@10KHz	I _{FP}	60	mA
Power Dissipation	PD	78	mW
Reverse Current @5V	I _r	10	μA
Electrostatic Discharge	ESD	2000	V
Operating Temperature	T _{opr}	- 40 ~ + 85	°C
Storage Temperature	T _{stg}	- 40 ~ + 100	°C

Typical Electrical & Optical Characteristics (Ta=25°C)

Items	Symbol	Min.	Typ.	Max.	UNIT	CONDITION
Luminous Intensity	I _v	320	500	----	mcd	I _F =20mA
Dominant Wavelength	λ _D	----	590	----	nm	I _F =20mA
Spectral Line Half-Width	Δλ	----	20	----	nm	I _F =20mA
Forward Voltage	V _F	1.7	----	2.6	V	I _F =20mA
Viewing Angle	2θ 1/2	----	120	----	deg	I _F =20mA

Note : 1.The forward voltage data did not including ±0.1V testing tolerance.
 2.The luminous intensity data did not including ±15% testing tolerance.
 3.The dominant wavelength data did not including ±1nm testing tolerance

Luminous Intensity Classification

BIN CODE	Iv(mcd) at 20mA	
	Min.	Max.
T	320	500
U	500	800
V	800	1250

Dominant Wavelength Classification

BIN CODE	λD (nm) at 20mA	
	Min.	Max.
16	587	589
17-1	589	590
17-2	590	591
17-3	591	592
18	592	595
19	595	600

Typical Electro-Optical Characteristics Curve

HYR CHIP

Fig.1 Forward current vs. Forward Voltage

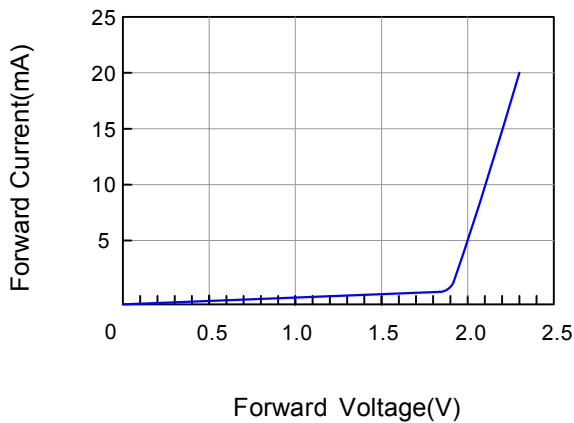

Fig.2 Relative Intensity vs. Forward Current

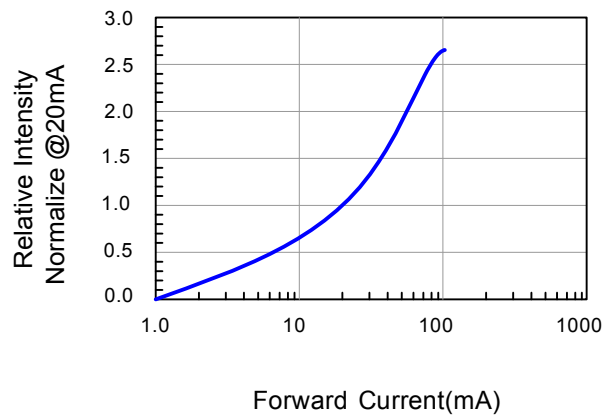

Fig.3 Forward Voltage vs. Temperature

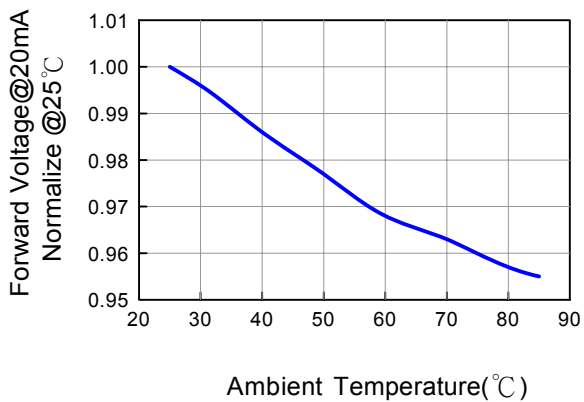

Fig.4 Relative Intensity vs. Temperature

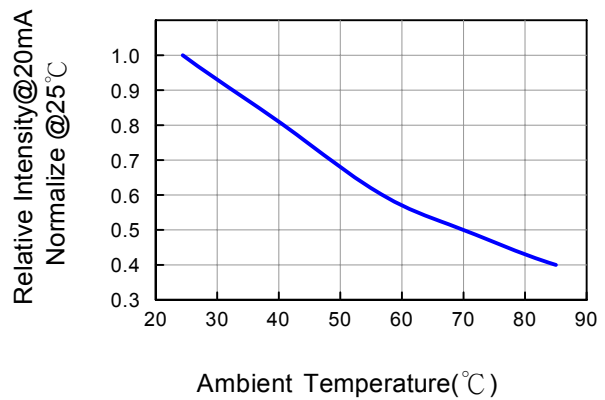

Fig.5 Relative Intensity vs. Wavelength

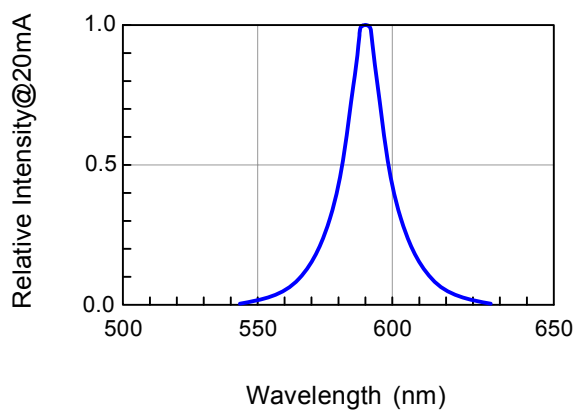
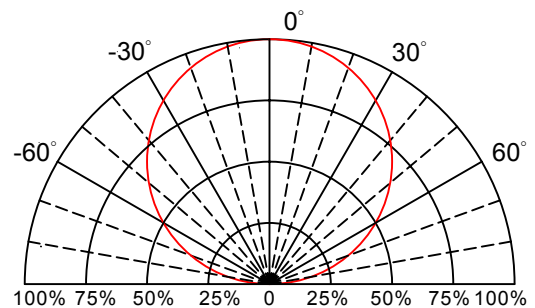
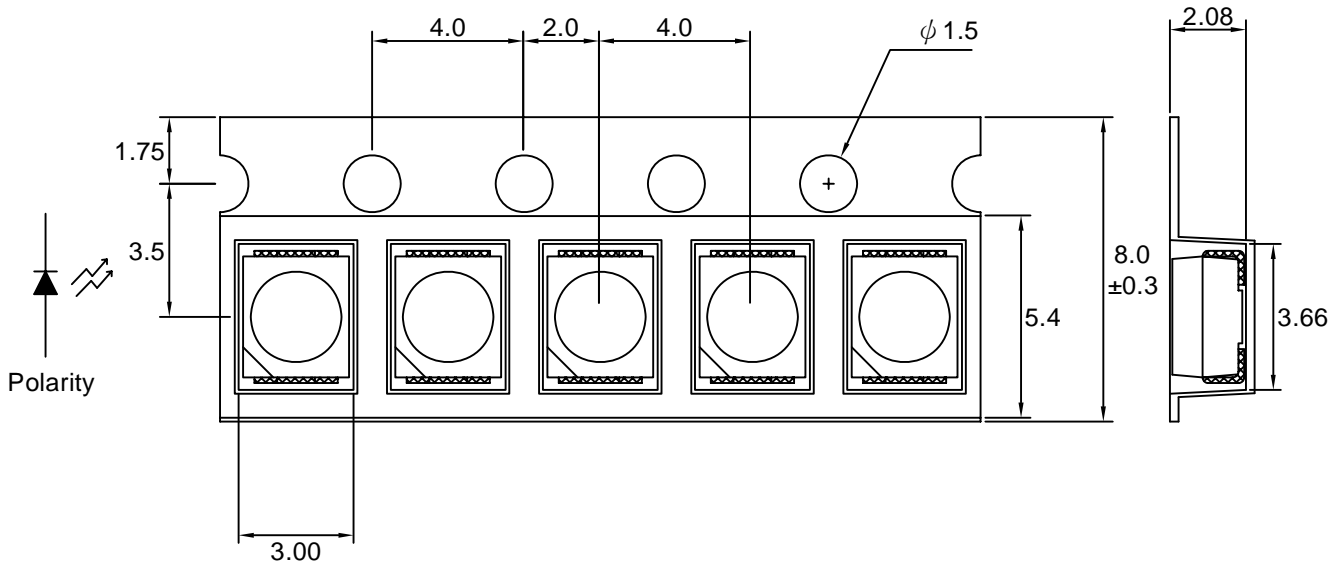

Fig.6 Directive Radiation



Carrier Type Dimensions







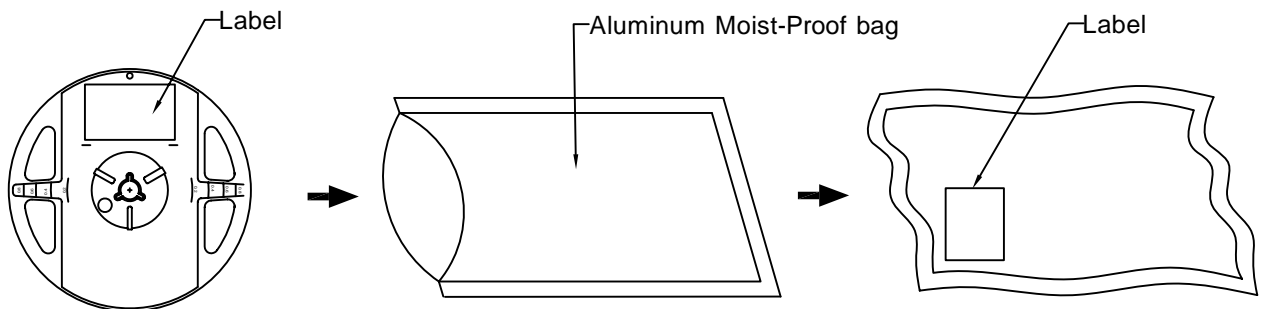

Note : The tolerances unless mentioned is ± 0.1 mm,Unit=mm.

• Packing Specifications



Part No.	Description	Quantity/Reel
LHY9553R/TR1-RG-B01	8.0mm tape,7"reel	2000 PCS

Label Explanation

	LIGITEK ELECTRONICS CO., LTD.	
PART :	LHY9553R/TR1-RG/A-B01	
LOT :	GS17B0168	
QTY(PCS):	2000	
BIN/HUE :	T/16	
		 VF: 1.7-2.6

BIN : Luminous Intensity

HUE : Dominant Wavelength

VF: Forward Voltage

Reel Dimensions

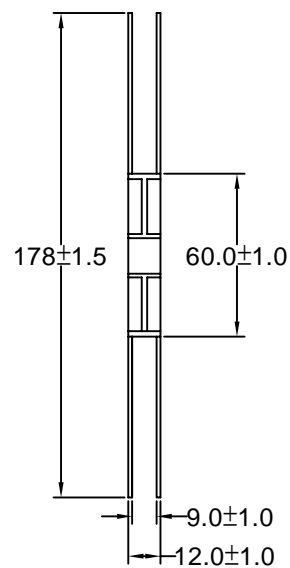
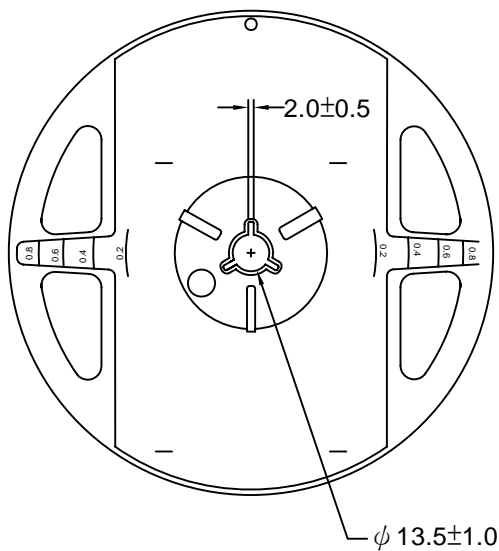

Box Explanation

1. 5 BAG / INNER BOX

2. INNER BOX SIZE : L X W X H 23cm X 8.5cm x 26cm

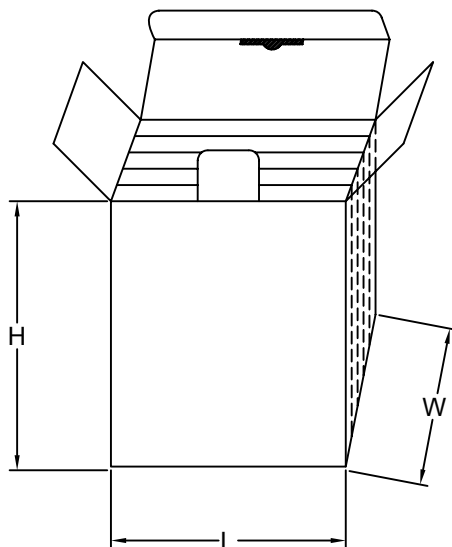

3. 10 INNER BOXES / CARTON

4. CARTON SIZE : L X W X H 58cm X 34cm x 35cm

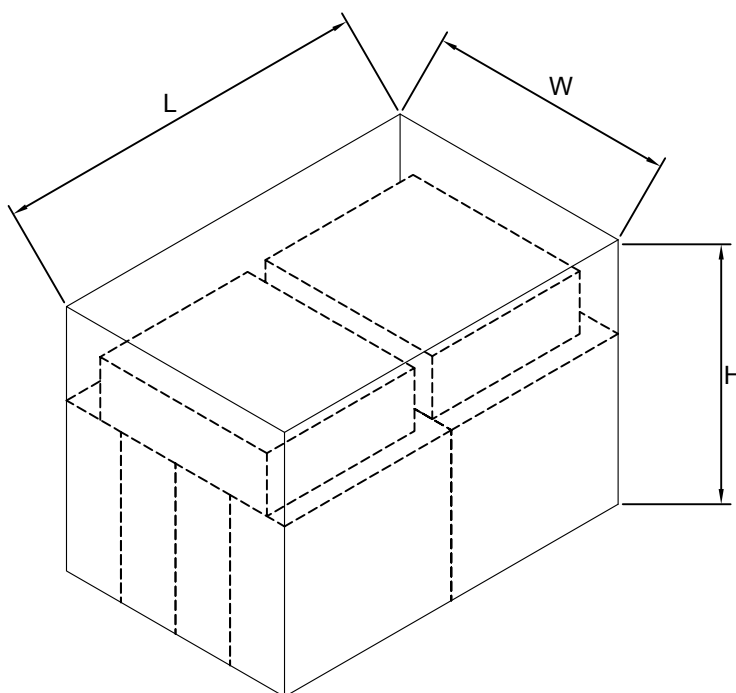

Recommended Soldering Conditions**1. Hand Solder**

Basic spec is $\leq 320^{\circ}\text{C}$ 3 sec one time only.

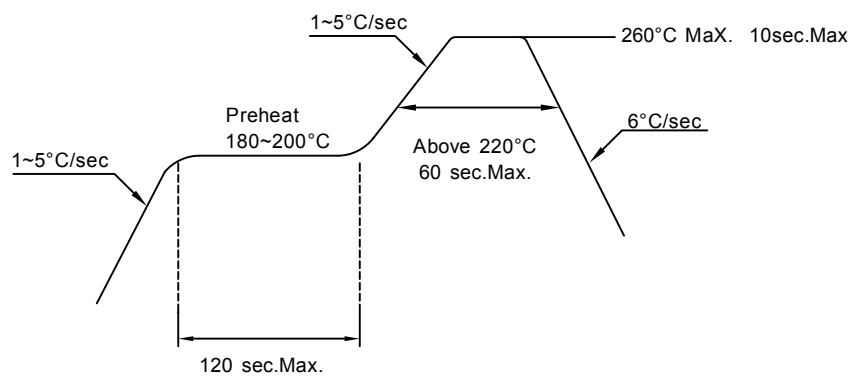
2. PB-Free Reflow Solder**Note:**

- 1.Reflow soldering should not be done more than two times.
- 2.When soldering,do not put stress on the LEDs during heating.
- 3.After soldering,do not warp the circuit board.

Precautions For Use:**Storage time:**

1. Calculated shelf life before opening is 12 months at $< 30^{\circ}\text{C}$ and $< 90\%$ relative humidity (RH)
2. After bag is opened, devices which will be subjected to reflow soldering or other high temperature processes must be
 - a) Assembled within 168 hours in an environment of $\leq 30^{\circ}\text{C} / 60\%$ RH, or
 - b) Stored at ambient of 10% RH or less
3. Devices are required baking before assembly if:
 - a) Humidity Indicator Card reads $>10\%$ (for level 2a -5a) or $>60\%$ (for level 2) at ambient temperature $23 \pm 5^{\circ}\text{C}$
 - b) 2.a) or 2.b) doesn't meet
4. If baking is required, devices should be baked for >72 hours at $60 \pm 5^{\circ}\text{C} / 5\%$ RH. Performing baking only once, and using the baked devices within 72 hours.

Drive Method:

LED is a current operated device, and therefore, requires some kind of current limiting incorporated into the driver circuit. This current limiting typically takes the form of a current limiting resistor placed in series with the LED.

Consider worst case voltage variations than could occur across the current limiting resistor. The forward current should not be allowed to change by more than 40% of its desired value.

Circuit model A

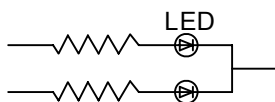

Circuit model B

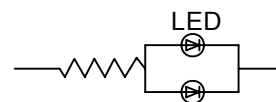

(A) Recommended circuit.

(B) The difference of brightness between LED could be found due to the VF-IF characteristics of LED.

Cleaning:

Use alcohol-based cleaning solvents such as isopropyl alcohol to clean the LED.

ESD(Electrostatic Discharge):

Static Electricity or power surge will damage the LED. Use of a conductive wrist band or anti-electrostatic glove is recommended when handling these LED. All devices, equipment and machinery must be properly grounded.

Reliability Test:

Classification	Test Item	Test Condition	Sample Size
Endurance Test	Operating Life Test	1.Ta=25°C 2.If=20mA 3.t=1000 hrs (-24hrs,+72hrs)	22
	High Temperature Storage Test	1.Ta=100°C±5°C 2.t=1000 hrs (-24hrs,+72hrs)	22
	Low Temperature Storage Test	1.Ta=-40°C±5°C 2.t=1000 hrs (-24hrs,+72hrs)	22
	High Temperature High Humidity Storage Test	1.Ta=85°C 2.RH=85% 3.t=1000hrs(-24hrs,+72hrs)	22
Environmental Test	Thermal Shock Test	1.Ta=100°C±5°C ~ -40°C±5°C 20min/ 10sec / 20min 2.total 100 cycles	22
	Temperature Cycling	1.100°C±5°C ~ -40°C±5°C 30mins / 5mins / 30mins 2.100 Cyeles	22
	IR Reflow	1.T=260°C Max. 10sec.Max. 2. 6 Min	22