







1.5 W Zener Diodes

<p>DO-204AL (DO-41)</p> 	<table style="width: 100%; border-collapse: collapse;"> <tr> <td style="text-align: center; padding: 5px;">Voltage 10 to 200 V</td> <td style="text-align: center; padding: 5px;">Power Dissipation 1.5 W</td> </tr> <tr> <td colspan="2" style="text-align: center; padding: 5px;"></td> </tr> </table> <p>FEATURES</p> <ul style="list-style-type: none"> • Glass passivated chip junction • Hyperectifier structure for high reliability • Cavity-free glass-passivated junction • Low leakage current • High surge current and zener capability • Low differential resistance • Tolerance series $\pm 5\%$ • Low forward voltage drop • Solder dip 260°C, 10s • AEC-Q101 qualified • Component in accordance to RoHS 2011/65/EU and WEEE 2002/96/EC • Halogen-free available according to IEC 61249-2-21 definition <div style="text-align: right; padding-right: 10px;">   RoHS <small>COMPLIANT</small> <small>HALOGEN</small> FREE </div> <p>MECHANICAL DATA</p> <ul style="list-style-type: none"> • Case: DO-204AL (DO-41). Epoxy meets UL 94V-0 flammability rating. • Polarity: Color band denotes cathode end. • Terminals: Matte tin plated leads, solderable per MIL-STD-750 Method 2026, J-STD-002 and JESD22-B102. Consumer grade, meets JESD 201 class 1A whisker test <p>TYPICAL APPLICATIONS</p> <p>Used for basic regulation functions in most electronic applications, Zener diodes offer a cheaper alternative to IC solutions.</p>	Voltage 10 to 200 V	Power Dissipation 1.5 W		
Voltage 10 to 200 V	Power Dissipation 1.5 W				
					

Maximum Ratings and Electrical Characteristics at 25 °C

SYMBOL	TYPE NUMBER	Value	Unit
P _{tot}	Power dissipation at T _{amb} = 60 °C	1.5	W
P _{ZSM}	Non repetitive peak zener dissipation (t = 10ms)	40	W
T _j	Operating Temperature Range	-55 to + 175	°C
T _{stg}	Storage Temperature Range	-55 to + 175	°C
V _F	Max. forward voltage drop at I _F = 1.0 A	1.1	V
R _{thj-a}	Max. thermal resistance at 10 mm. lead length	50	°C/W

1.5 W Zener Diodes

Ordering information

PREFERRED P/N	PACKAGE CODE	DELIVERY MODE	BASE QUANTITY	UNIT WEIGHT (g)
BZY97C20GP AMP	AMP	AMMO BOX	5,000	0.325
BZY97C20GP TR	TR	14" diameter tape and reel	5,000	0.325
BZY97C20GP HF AMP	AMP	AMMO BOX	5,000	0.325
BZY97C20GP HF TR	TR	14" diameter tape and reel	5,000	0.325

Package Outline Dimensions: (mm) DO-204AL (DO-41)

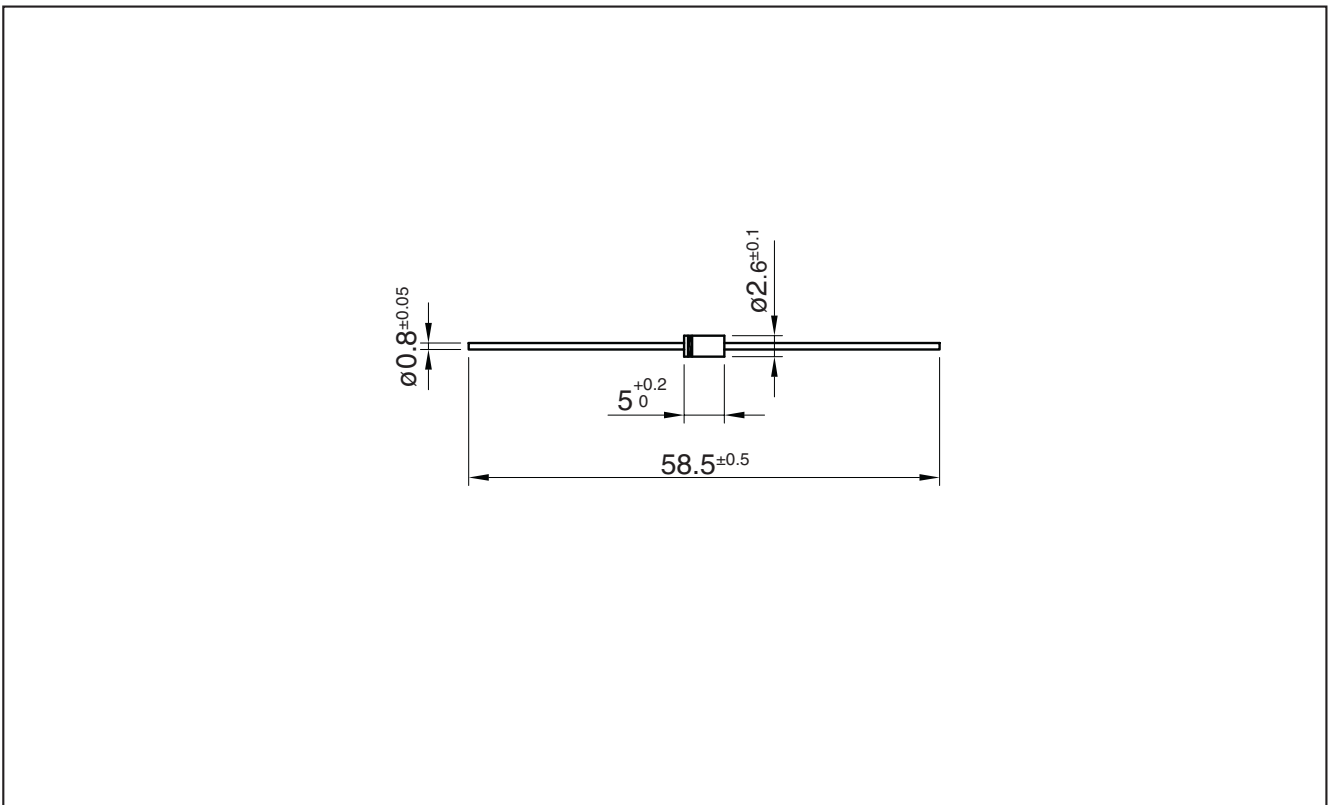

1.5 W Zener Diodes

Type	Zener Voltage Range V_Z at I_{ZT}	Maximum Zener Impedance Z_{ZT} at I_{ZT}	Typical Temperature Coefficient at I_{ZT}	Test Current I_{ZT}	Min. Reverse Voltage at $I_R = 1 \mu A$ V_R
	(V)	(Ω)	(% / $^{\circ}C$)	(mA)	(V)
BZY97C10 GP	9.4 - 10.6	4	+ 0.070	50	5.0
BZY97C11 GP	10.4 - 11.6	7	+ 0.075	50	5.0
BZY97C12 GP	11.4 - 12.7	7	+ 0.075	50	7.0
BZY97C13 GP	12.4 - 14.1	10	+ 0.075	50	7.0
BZY97C15 GP	13.8 - 15.8	10	+ 0.075	50	10
BZY97C16 GP	15.3 - 17.1	15	+ 0.085	25	10
BZY97C18 GP	16.8 - 19.1	15	+ 0.085	25	10
BZY97C20 GP	18.8 - 21.2	15	+ 0.085	25	10
BZY97C22 GP	20.8 - 23.3	15	+ 0.085	25	12
BZY97C24 GP	22.8 - 25.6	15	+ 0.085	25	12
BZY97C27 GP	25.1 - 28.9	15	+ 0.085	25	14
BZY97C30 GP	28 - 32	15	+ 0.085	25	14
BZY97C33 GP	31 - 35	15	+ 0.085	25	17
BZY97C36 GP	34 - 38	40	+ 0.085	10	17
BZY97C39 GP	37 - 41	40	+ 0.085	10	20
BZY97C43 GP	40 - 46	45	+ 0.095	10	20
BZY97C47 GP	44 - 50	45	+ 0.095	10	24
BZY97C51 GP	48 - 54	60	+ 0.095	10	24
BZY97C56 GP	52 - 60	60	+ 0.095	10	28
BZY97C62 GP	58 - 66	80	+ 0.105	10	28
BZY97C68 GP	64 - 72	80	+ 0.105	10	34
BZY97C75 GP	70 - 79	100	+ 0.105	10	34
BZY97C82 GP	77 - 88	100	+ 0.105	10	41
BZY97C91 GP	85 - 96	200	+ 0.11	5	41
BZY97C100 GP	94 - 106	200	+ 0.11	5	50
BZY97C110 GP	104 - 116	250	+ 0.11	5	50
BZY97C120 GP	114 - 127	250	+ 0.11	5	60
BZY97C130 GP	124 - 141	300	+ 0.11	5	60
BZY97C150 GP	138 - 156	300	+ 0.11	5	75
BZY97C160 GP	153 - 171	400	+ 0.11	5	75
BZY97C180 GP	168 - 191	500	+ 0.11	5	90
BZY97C200 GP	188 - 212	500	+ 0.11	5	90

1.5 W Zener Diodes

Ratings and Characteristics (Ta 25 °C unless otherwise noted)

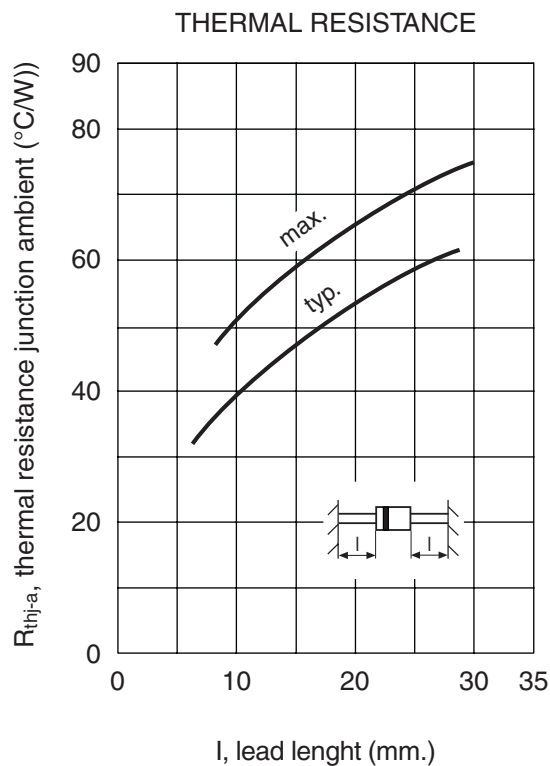
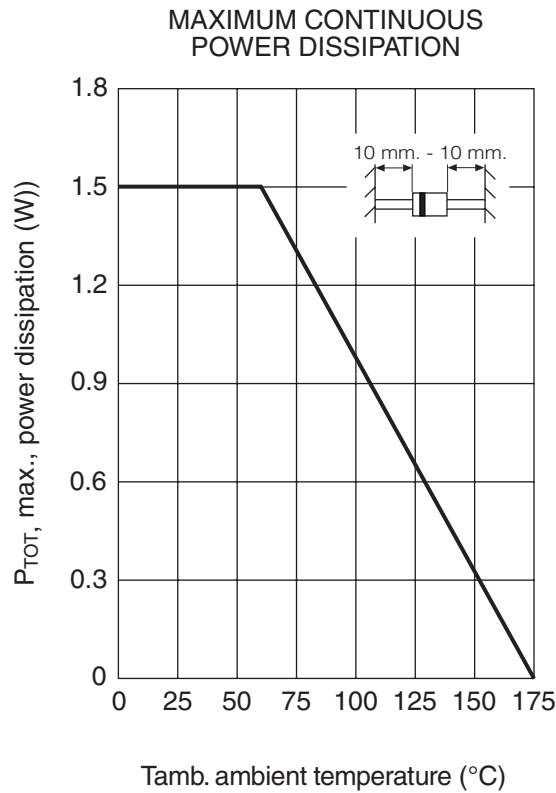

1.5 W Zener Diodes

Ratings and Characteristics (Ta 25 °C unless otherwise noted)

BREAKDOWN CHARACTERISTICS

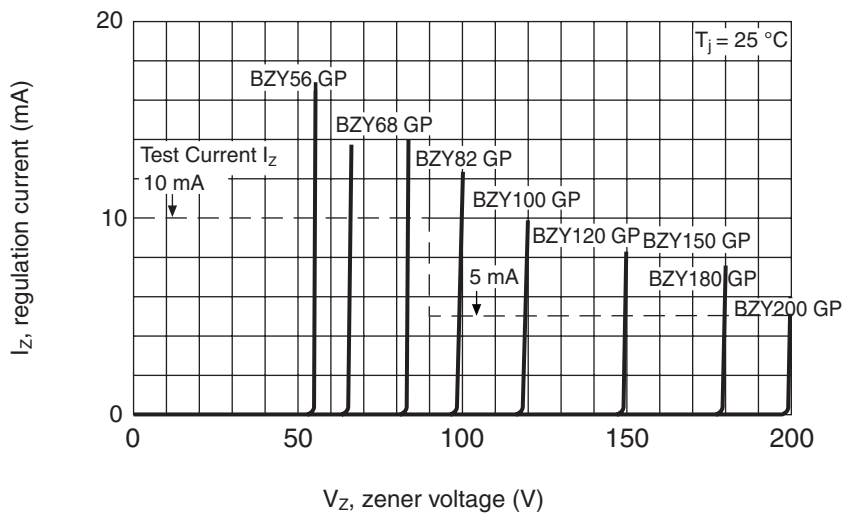
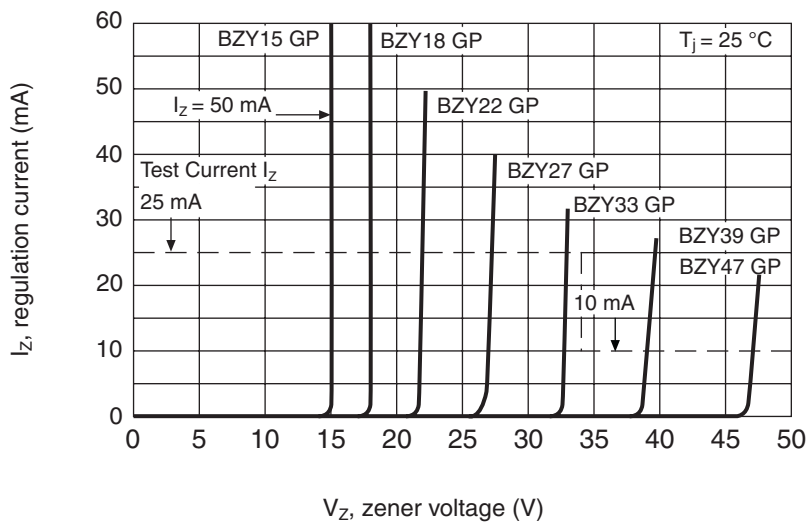
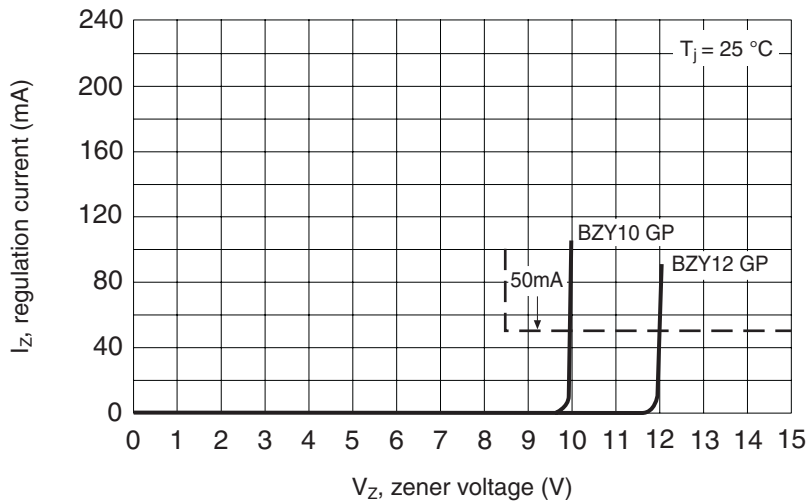

1.5 W Zener Diodes

Ratings and Characteristics (Ta 25 °C unless otherwise noted)

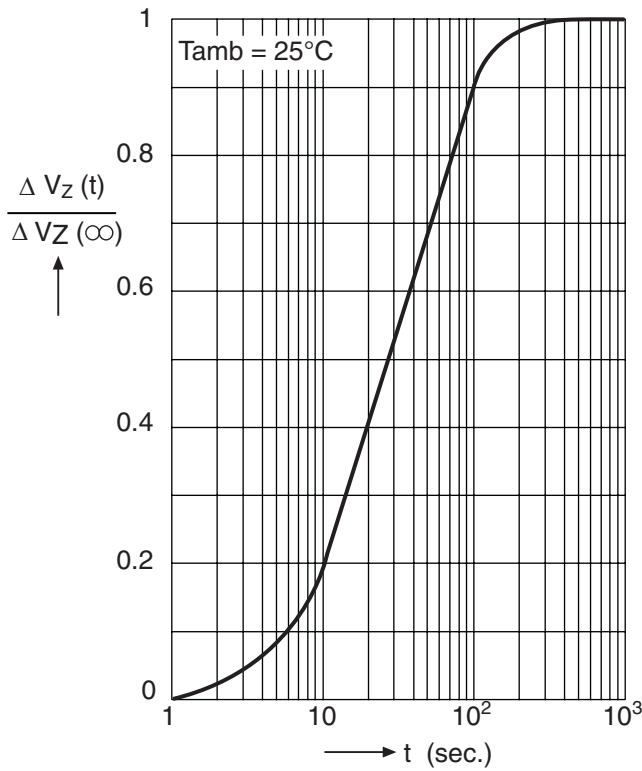

Relative change of Zener voltage versus turn-on time.

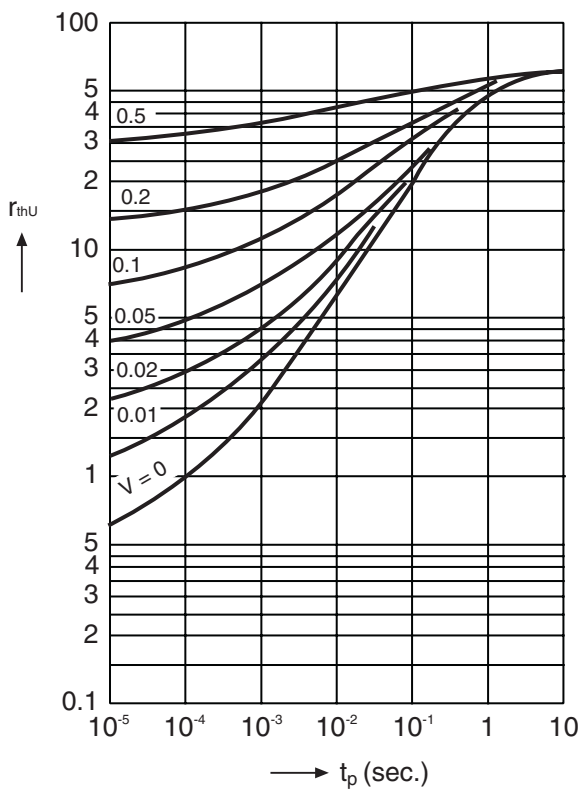

Pulse thermal resistance versus pulse duration. Valid provided that leads are kept at ambient temperature at a distance of 10mm. from case.

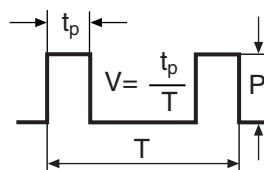

1.5 W Zener Diodes

Disclaimer

All product, product specifications and data are subject to change without notice to improve reliability, function or design or otherwise.

Fagor Electrónica, S.Coop., its affiliates, agents, and employees, and all persons acting on its or their behalf (collectively, "Fagor"), disclaim any and all liability for any errors, inaccuracies or incompleteness contained in any datasheet or in any other disclosure relating to any product.

Fagor makes no warranty, representation or guarantee regarding the suitability of the products for any particular purpose or the continuing production of any product. To the maximum extent permitted by applicable law, Fagor disclaims (i) any and all liability arising out of the application or use of any product, (ii) any and all liability, including without limitation special, consequential or incidental damages, and (iii) any and all implied warranties, including warranties of fitness for particular purpose, non-infringement and merchantability.

Statements regarding the suitability of products for certain types of applications are based on Fagor's knowledge of typical requirements that are often placed on Fagor products in generic applications. Such statements are not binding statements about the suitability of products for a particular application. It is the customer's responsibility to validate that a particular product with the properties described in the product specification is suitable for use in a particular application. Parameters provided in datasheets and/or specifications may vary in different applications and performance may vary over time. All operating parameters, including typical parameters, must be validated for each customer application by the customer's technical experts. Product specifications do not expand or otherwise modify Fagor's terms and conditions of purchase, including but not limited to the warranty expressed therein.

Except as expressly indicated in writing, Fagor products are not designed for use in medical, life-saving, or life-sustaining applications or for any other application in which the failure of the Fagor product could result in personal injury or death. Customers using or selling Fagor products not expressly indicated for use in such applications do so at their own risk and agree to fully indemnify and hold Fagor and its distributors harmless from and against any and all claims, liabilities, expenses and damages arising or resulting in connection with such use or sale, including attorneys fees, even if such claim alleges that Fagor or its distributor was negligent regarding the design or manufacture of the part. Please contact authorized Fagor personnel to obtain written terms and conditions regarding products designed for such applications.

No license, express or implied, by estoppel or otherwise, to any intellectual property rights is granted by this document or by any conduct of Fagor, Product names and markings noted herein may be trademarks of their respective owners.