



LIGITEK ELECTRONICS CO.,LTD.
Property of Ligitek Only

LED SMD



Lead-Free Parts

LG-197RGB-CT

DATA SHEET

DOC. NO : QW0905-LG-197RGB-CT

REV. : C

DATE : 06 - Nov. - 2015



Features:

1. Package in 8.0mm carrier tape on 7" diameter reel.
2. Compatible with automatic placement equipment.
3. Compatible with infrared and vapor phase reflow solder process.

Descriptions:

1. The LG-197 SMD Taping is much smaller than lead frame type components, thus enable smaller board size, higher packing density, reduced storage space and finally smaller equipment to be obtained.
2. Besides, lightweight makes them ideal for miniature applications. etc.

Applications:

1. Automotive : backlighting in dashboard and switch.
2. Telecommunication : indicator and backlighting in telephone and fax.
3. Flat backlight for LCD, switch and symbol
4. General use.

Device Selection Guide:

PART NO	MATERIAL	COLOR	
		Emitted	Lens
LG-197RGB-CT	AlGaInP	Red	Water Clear
	InGaN	Green	
	InGaN	Blue	

Package Dimensions

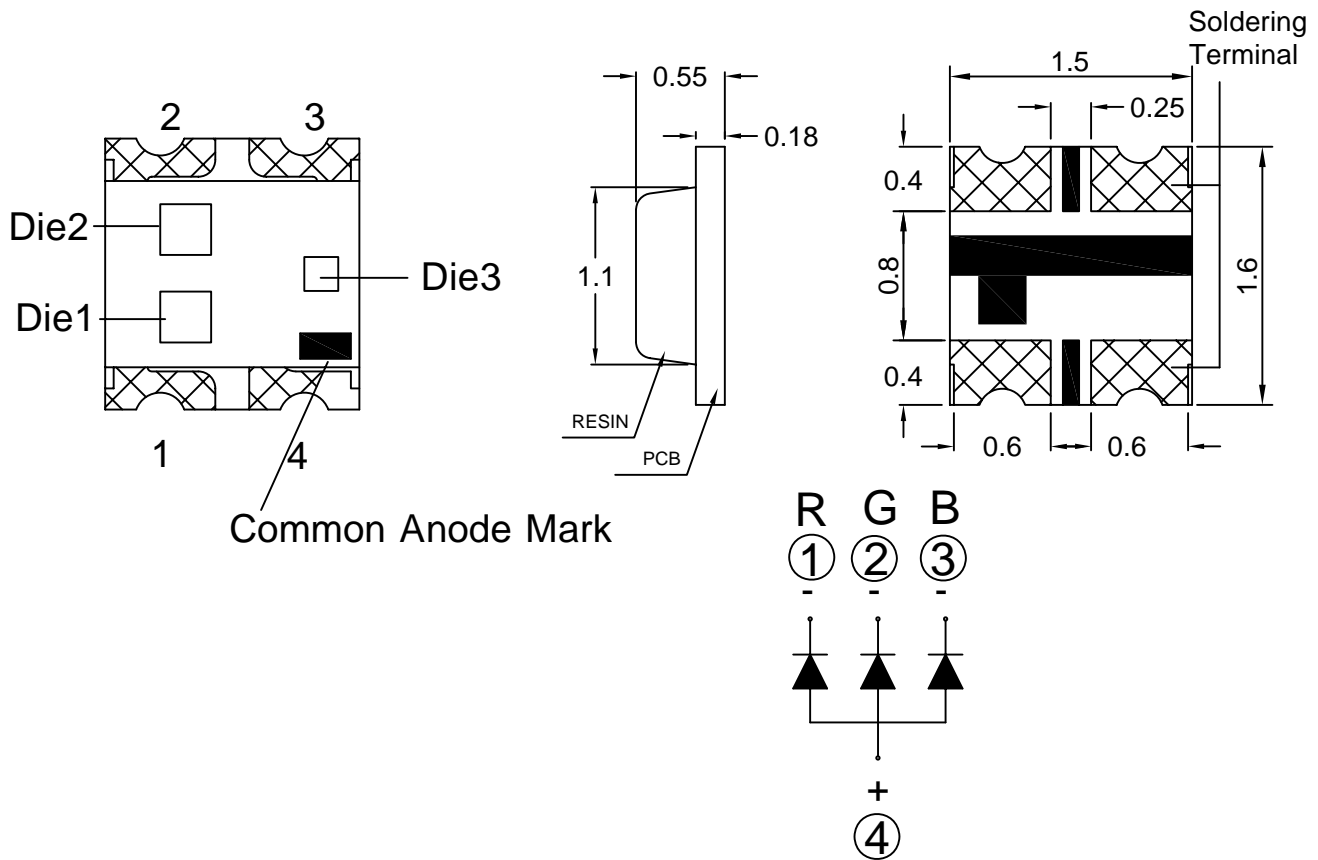

Note : 1.All dimension are in millimeter tolerance is ± 0.1 mm unless otherwise noted.
2.Specifications are subject to change without notice.

Recommended Soldering Pad Dimensions

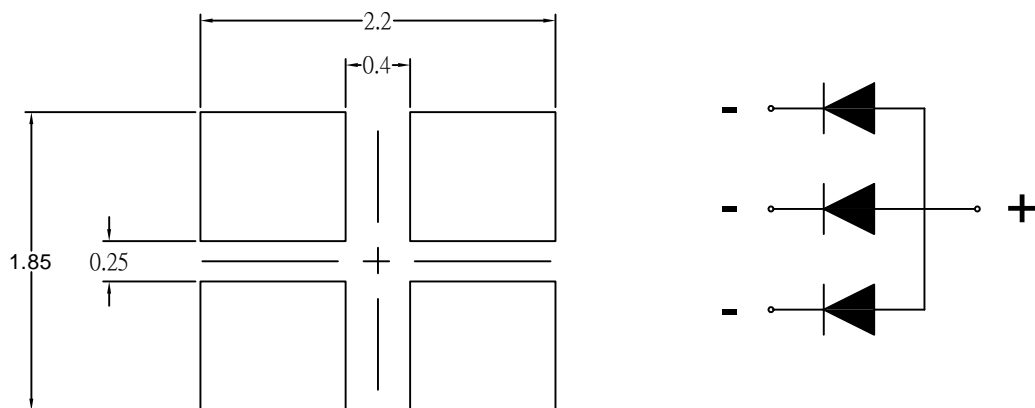

Note : The tolerances unless mentioned is ± 0.1 mm, Angle ± 0.5 . Unit=mm.

Absolute Maximum Ratings at Ta=25°C

Parameter	Symbol	Ratings			UNIT
		URF	DGM	DBK	
Power Dissipation	PD	60	72	72	mW
Peak Forward Current Duty 1/10@10KHz	IFP	130	100	100	mA
Forward Current	IF	25	20	20	mA
Reverse Current @5V	Ir	10	50	50	μA
Electrostatic Discharge(HBM)	ESD	2000	500		V
Operating Temperature	Topr	-40 ~ +85			°C
Storage Temperature	Tstg	-40 ~ +100			°C

Typical Electrical & Optical Characteristics (Ta=25°C)

Items	Symbol	Min.	Typ.	Max.	UNIT	CONDITION
Luminous Intensity	URF	50	100	----	mcd	IF=20mA
	DGM	320	500	----		
	DBK	50	125	----		
Dominant Wavelength	URF	----	630	----	nm	IF=20mA
	DGM	----	525	----		
	DBK	----	470	----		
Spectral Line Half-Width	URF	----	20	----	nm	IF=20mA
	DGM	----	36	----		
	DBK	----	30	----		
Forward Voltage	URF	1.5	----	2.4	V	IF=20mA
	DGM	2.8	----	3.6		
	DBK	2.8	----	3.6		
Viewing Angle	URF	----	140	----	deg	IF=20mA
	DGM	----	140	----		
	DBK	----	140	----		

Luminous Intensity Classification

BIN CODE		lv(mcd) at 20mA	
		Min.	Max.
URF	P	50	80
	Q	80	125
	R	125	200

BIN CODE		lv(mcd) at 20mA	
		Min.	Max.
DGM	T	320	500
	U	500	800
	V	800	1250

BIN CODE		lv(mcd) at 20mA	
		Min.	Max.
DBK	P	50	80
	Q	80	125
	R	125	200

Typical Electro-Optical Characteristics Curve

URF CHIP

Fig.1 Forward current vs. Forward Voltage

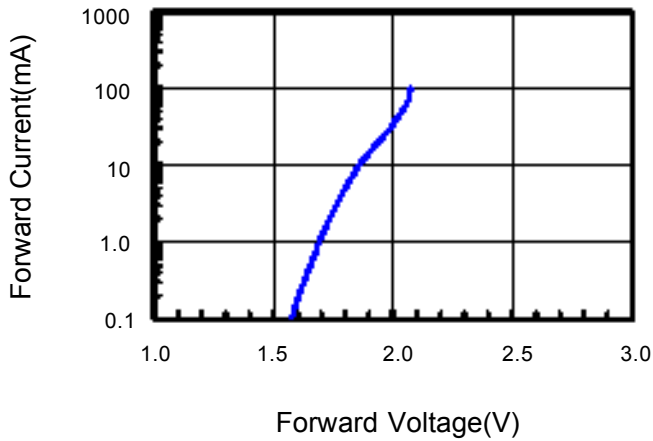

Fig.2 Relative Intensity vs. Forward Current

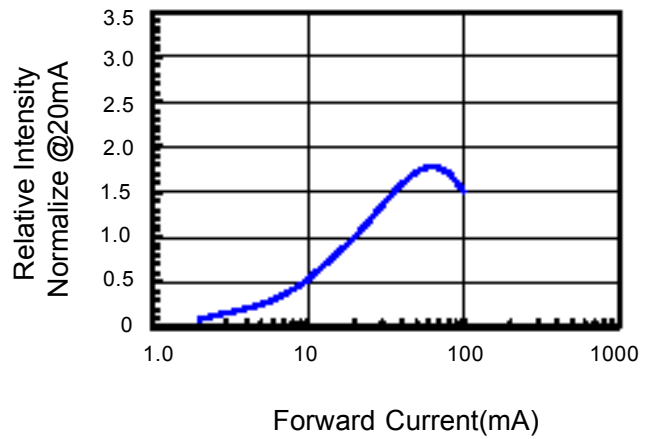

Fig.3 Forward Current vs. Temperature

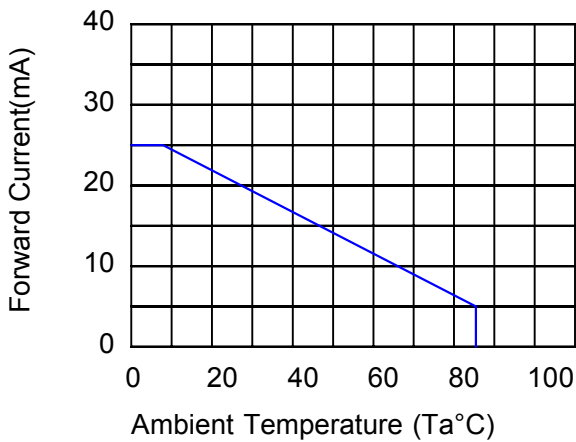

Fig.4 Relative Intensity vs. Temperature

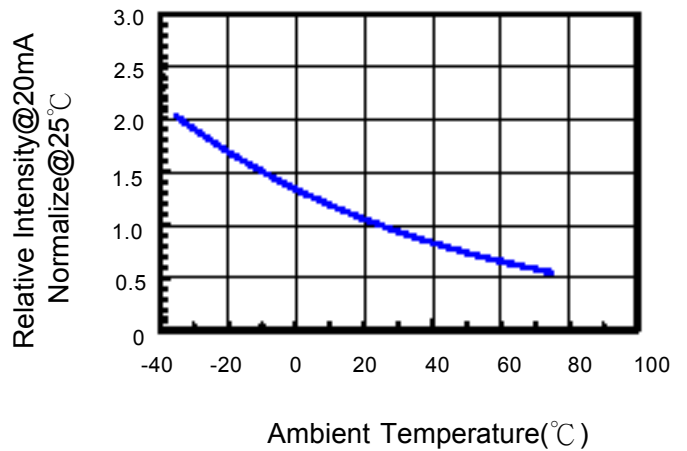

Fig.5 Relative Intensity vs. Wavelength

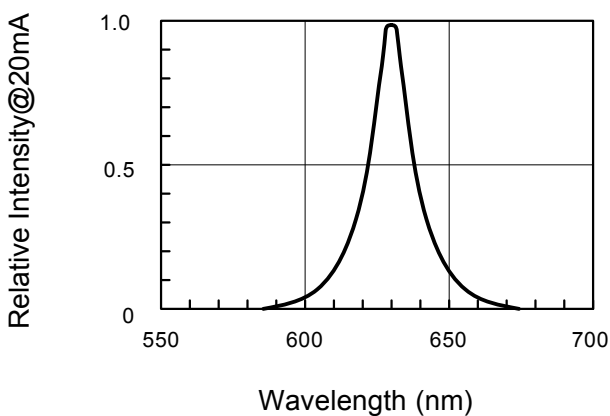
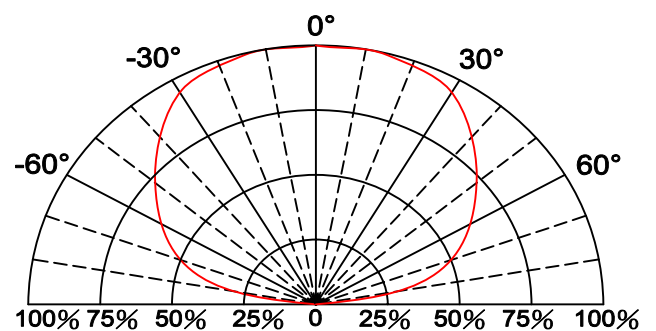

Fig.6 Directive Radiation



Typical Electro-Optical Characteristics Curve

DGM CHIP

Fig.1 Forward current vs. Forward Voltage

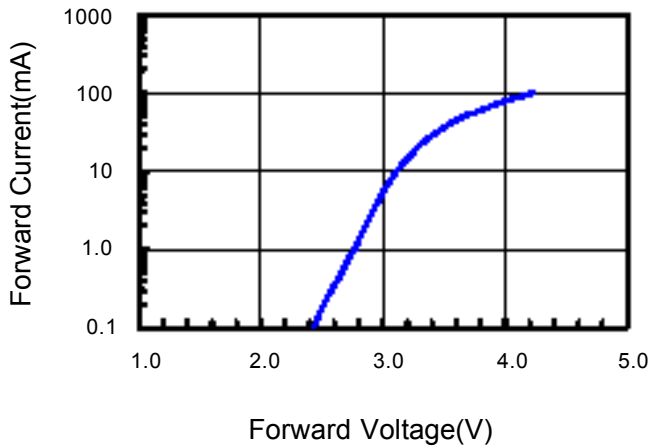

Fig.2 Relative Intensity vs. Forward Current

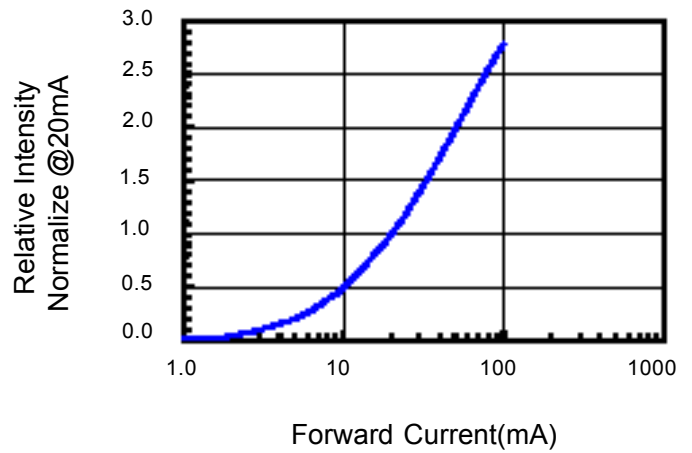

Fig.3 Forward Current vs. Temperature

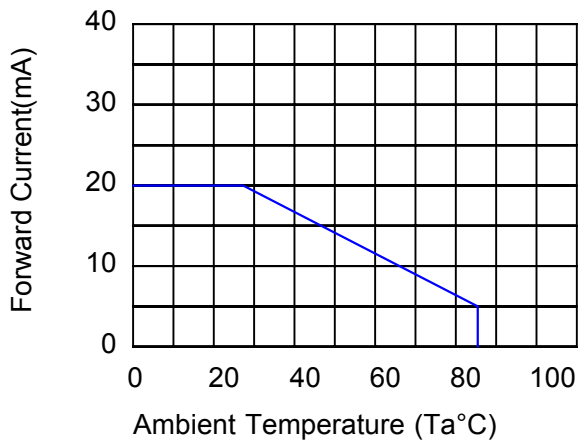

Fig.4 Relative Intensity vs. Temperature

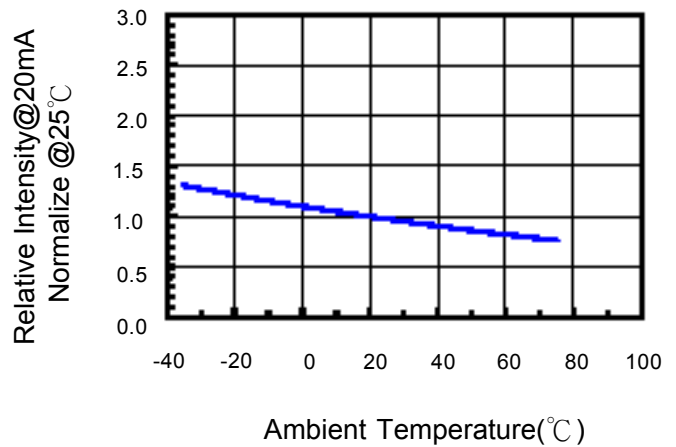

Fig.5 Relative Intensity vs. Wavelength

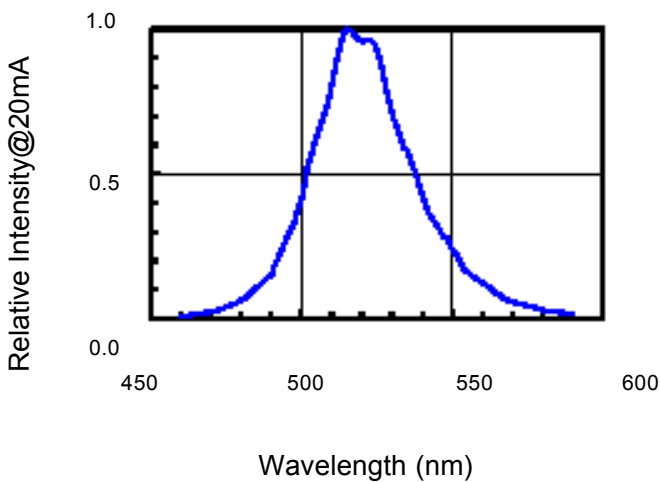
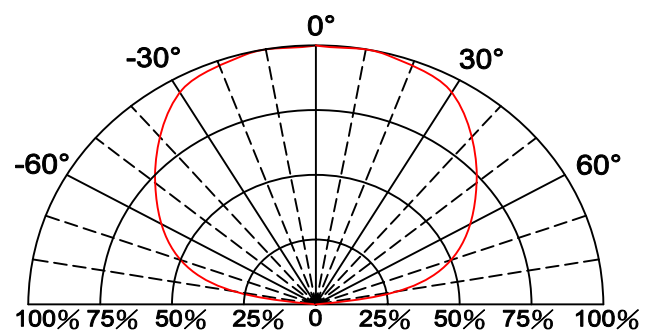

Fig.6 Directive Radiation



Typical Electro-Optical Characteristics Curve

DBK CHIP

Fig.1 Forward current vs. Forward Voltage

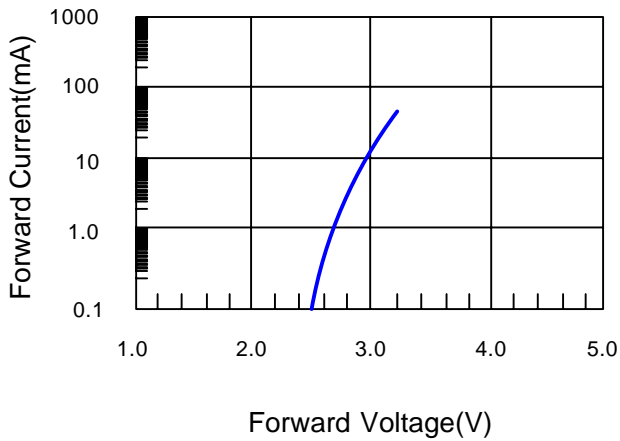

Fig.2 Relative Intensity vs. Forward Current

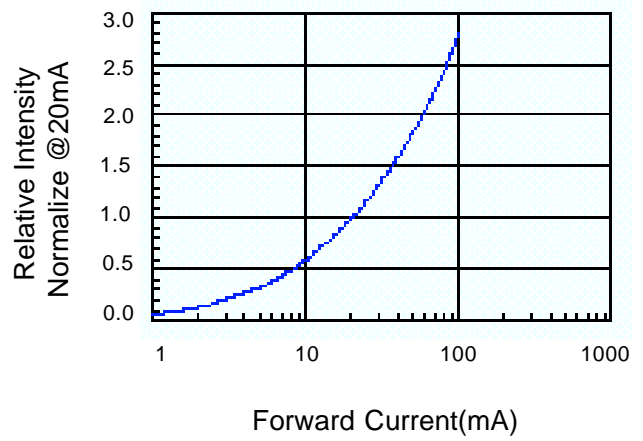

Fig.3 Forward Current vs. Temperature

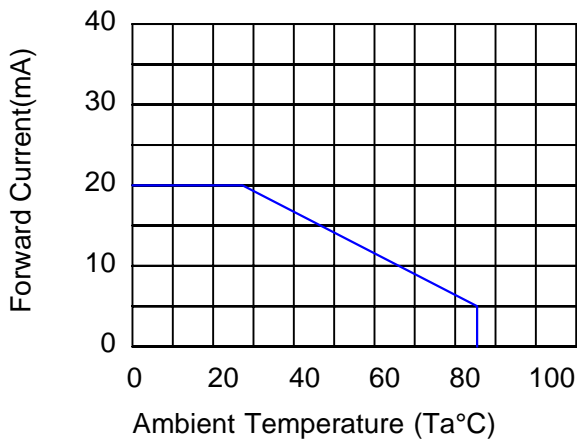

Fig.4 Relative Intensity vs. Temperature

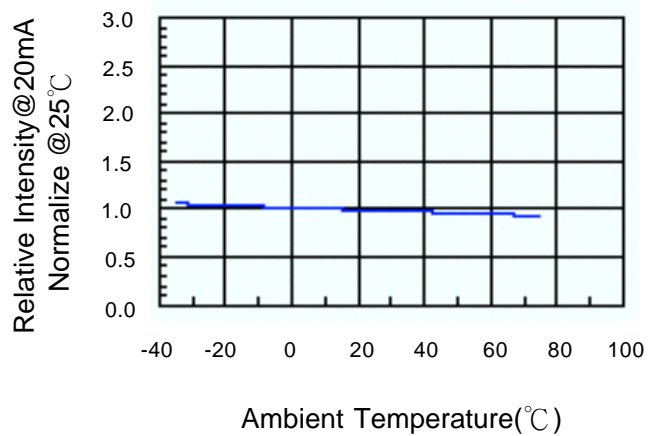

Fig.5 Relative Intensity vs. Wavelength

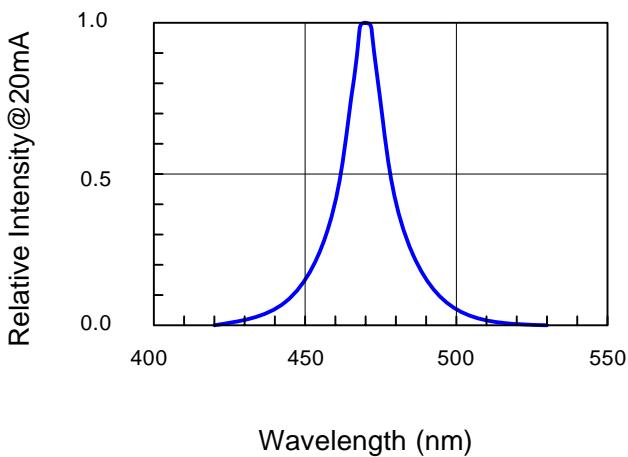
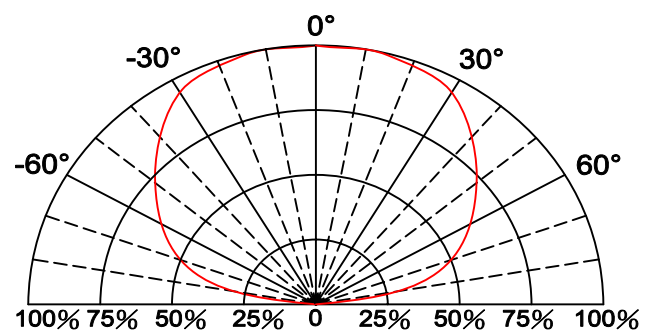
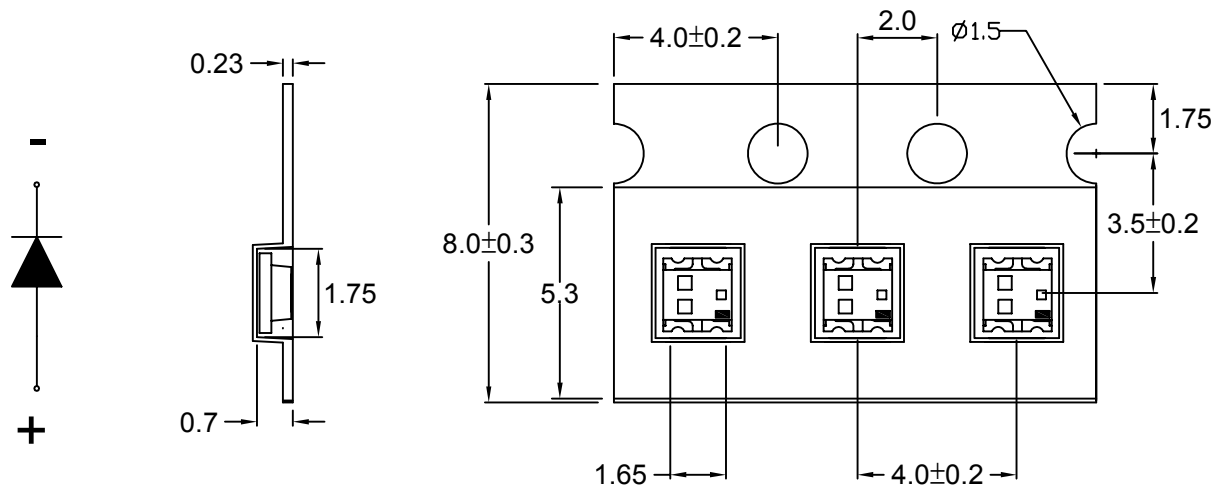

Fig.6 Directive Radiation



Carrier Tape Dimensions







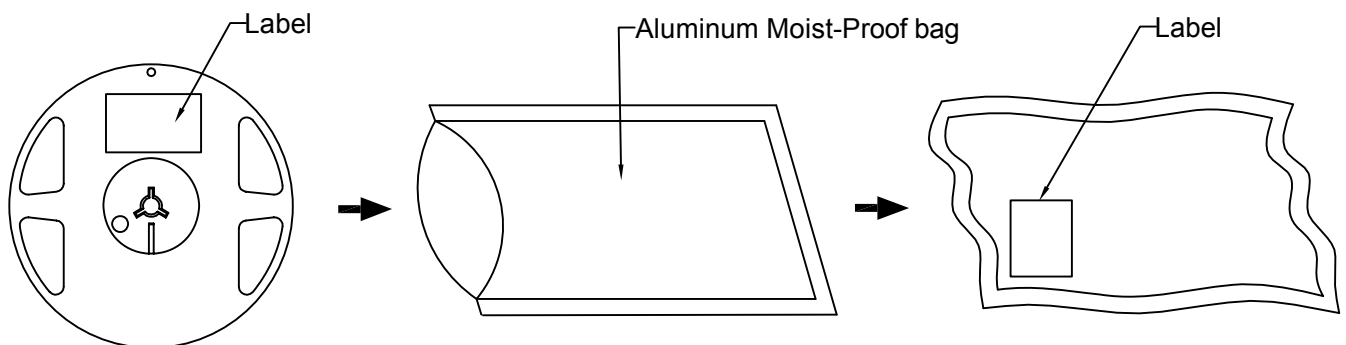



Note : The tolerances unless mentioned is $\pm 0.1\text{mm}$, Angle ± 0.5 . Unit=mm.

• Packing Specifications



Part No.	Description	Quantity/Reel
LG-197RGB-CT	8.0mm tape,7"reel	4000 devices

Label Explanation

		LIGITEK ELECTRONICS CO., LTD.	
PART :	LG-197RGB-CT		
LOT :	GS113A0168		
QTY(PCS):	4000		
BIN/HUE :	P-U-R		
		VF:1.5-2.4	VF:2.8-3.6
		VF:2.8-3.6	VF:2.8-3.6

BIN : Luminous Intensity

VF : Forward Voltage

Reel Dimensions

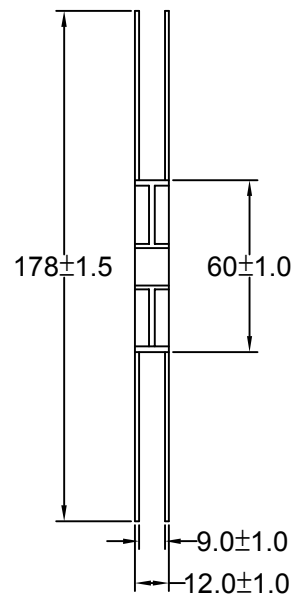
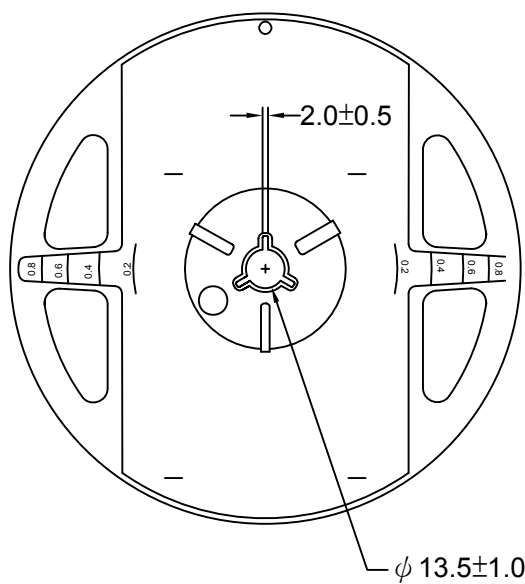

Box Explanation

1. 5 BAG / INNER BOX

2. INNER BOX SIZE : L X W X H 23cm X 8.5cm x 26cm

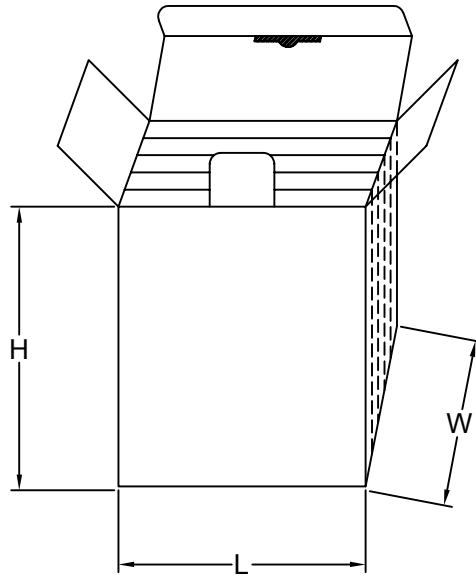

3. 10 INNER BOXES / CARTON

4. CARTON SIZE : L X W X H 58cm X 34cm x 35cm

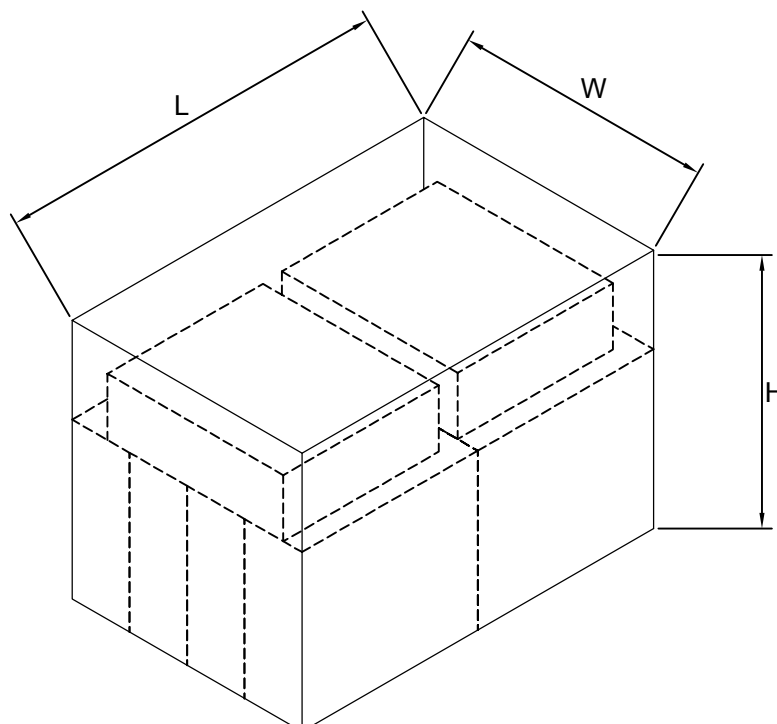

Recommended Soldering Conditions**1. Hand Solder**

Basic spec is $\leq 280^{\circ}\text{C}$ 3 sec one time only.

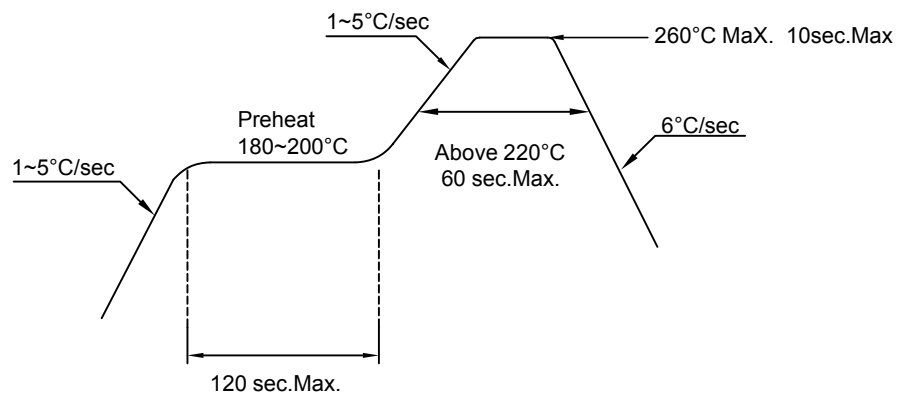
2. PB-Free Reflow Solder**Note:**

- 1.Reflow soldering should not be done more than two times.
- 2.When soldering,do not put stress on the LEDs during heating.
- 3.After soldering,do not warp the circuit board.

Precautions For Use:**Storage time:**

- 1.The operation of Temperatures and RH are : $5^{\circ}\text{C}\sim 30^{\circ}\text{C}$,RH60%.
- 2.Once the package is opened, the products should be used within a week.
Otherwise, they should be kept in a damp proof box with descanting agent.
Considering the tape life, we suggest our customers to use our products within a year(from production date).
- 3.If opened more than one week in an atmosphere $5^{\circ}\text{C} \sim 30^{\circ}\text{C}$,RH60%, they should be treated at $60^{\circ}\text{C}\pm 5^{\circ}\text{C}$ for 24hrs.

Drive Method:

LED is a current operated device, and therefore, requirer some kind of current limiting incorporated into the driver circuit. This current limiting typically takes the form of a current limiting resistor placed in series with the LED.

Consider worst case voltage variations than could occur across the current limiting resistor. The forward current should not be allowed to change by more than 40% of its desired value.

Circuit model A

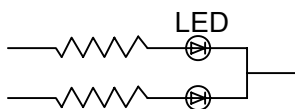

Circuit model B

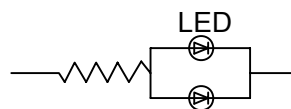

(A) Recommended circuit.

(B) The difference of brightness between LED could be found due to the VF-IF characteristics of LED.

Cleaning:

Use alcohol-based cleaning solvents such as isopropyl alcohol to clean the LED.

ESD(Electrostatic Discharge):

Static Electricity or power surge will damage the LED. Use of a conductive wrist band or anti-electrosatic glove is recommended when handing these LED. All devices, equipment and machinery must be properly grounded.

Reliability Test:

Classification	Test Item	Test Condition	Sample Size
Endurance Test	Operating Life Test	1.Ta=25°C 2.If=20mA 3.t=1000 hrs (-24hrs,+72hrs)	22
	High Temperature Storage Test	1.Ta=100°C±5°C 2.t=1000 hrs (-24hrs,+72hrs)	22
	Low Temperature Storage Test	1.Ta=-40°C±5°C 2.t=1000 hrs (-24hrs,+72hrs)	22
	High Temperature High Humidity Storage Test	1.Ta=85°C 2.RH=85% 3.t=1000hrs(-24hrs,+72hrs)	22
Environmental Test	Thermal Shock Test	1.Ta=100°C±5°C ~ -40°C±5°C 20min/ 10sec / 20min 2.total 100 cycles	22
	Temperature Cycling	1.100°C±5°C ~ -40°C±5°C 30mins / 5mins / 30mins 2.100 Cyeles	22
	IR Reflow	1.T=260°C Max. 10sec.Max. 2. 6 Min	22