

**DLC Display Co., Limited**

**德爾西顯示器有限公司**



MODEL No: DLC0283QZC

TEL: 86-755-86029824

FAX: 86-755-86029827

E-MAIL: [sales@dlcdisplay.com](mailto:sales@dlcdisplay.com)

WEB: [www.dlcdisplay.com](http://www.dlcdisplay.com)

### Record of Revision

Date	Revision No.	Summary
2017-01-04	1.0	Rev 1.0 was issued

### 1. Scope

This data sheet is to introduce the specification of DLC0283QZC active matrix TFT module. It is composed of a color TFT-LCD panel, driver IC, FPC and a backlight unit. The 2.83" display area contains 240(RGB) x 320 pixels.

### 2. Application

Digital equipments which need color display, mobile phone, mobile navigator/video systems.

### 3. General Information

Item	Contents	Unit
Size	2.83	inch
Resolution	240(RGB) x 320	/
Interface	MCU	/
Technology type	a-Si	/
Pixel Configuration	R.G.B. Vertical Stripe	
Outline Dimension (W x H x D)	50.0 x 69.2 x 2.7	mm
Active Area	43.2 x 57.6	mm
Display Mode	Transmissive, Normally white	/
View Direction	6 O'clock	
Backlight Type	LED	/
Driver IC	ILI9341V	/
Weight	TBD	g

### 4. Outline Drawing

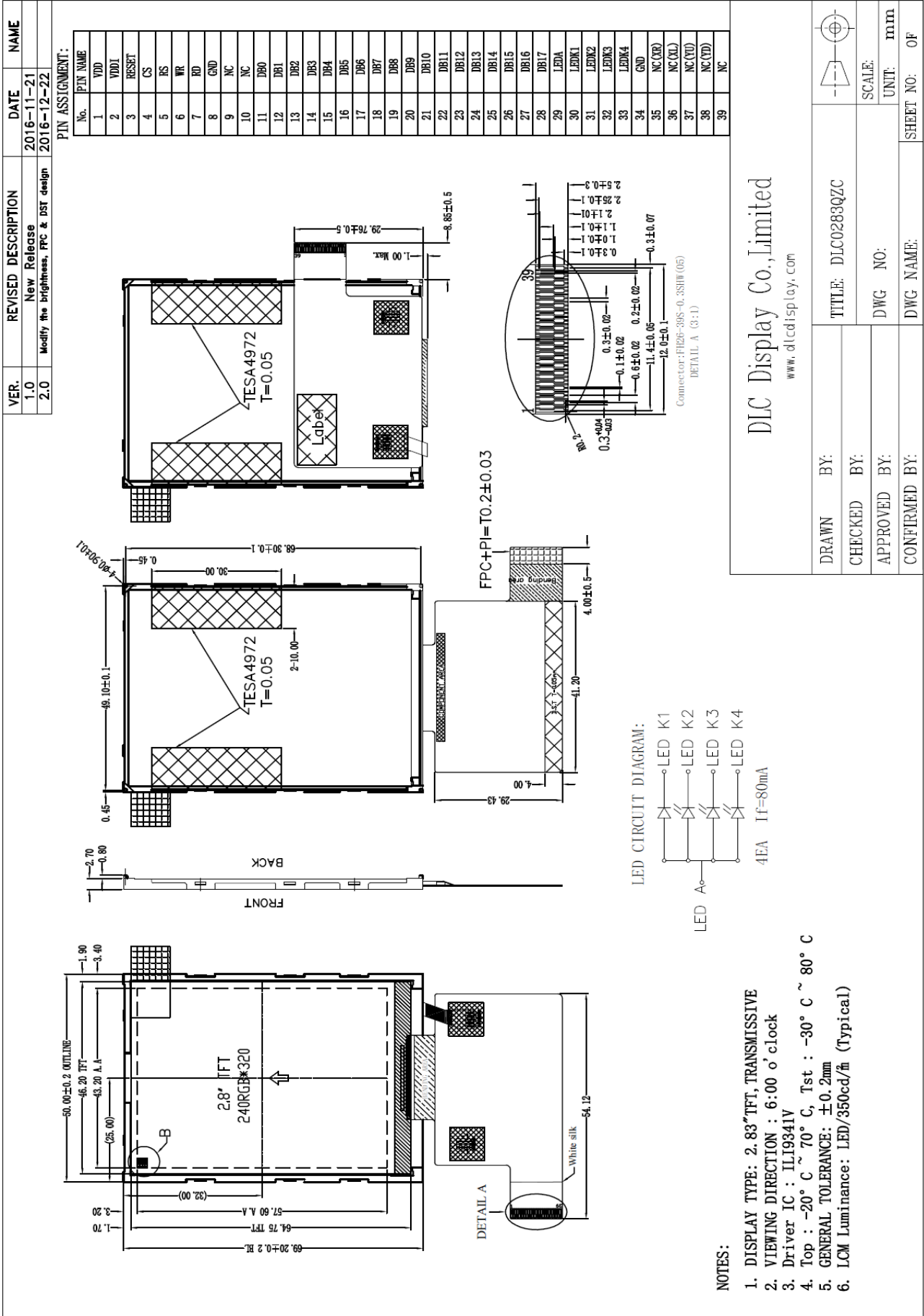

**5. Interface signals**

Pin No.	Symbol	I/O	Function
1	VCC	P	Power Supply
2	VDDI	P	Power Supply for logic
3	RESET	I	Reset signal
4	CS	I	Chip select signal
5	RS	I	Register select signal
6	WR	I	Write strobe signal and activates when the signal is low
7	RD	I	Read strobe signal and activates when the signal is low
8	GND	P	Ground
9~10	NC	-	No Connection
11~28	DB0 ~ DB17	I	Data input
29	LED-A	P	LED anode
30~33	LED-K1 ~ LED-K4	P	LED cathode
34	GND	P	Ground
35	NC(XR)	O	No connection( Touch control pin)
36	NC(XL)	O	
37	NC(YU)	O	
38	NC(YD)	O	
39	NC	-	No Connection

## 6. Absolute maximum Ratings

### 6.1. Electrical Absolute max. ratings

Parameter	Symbol	MIN	MAX	Unit	Remark
Power Supply for Analog	VCC	-0.3	3.6	V	

Notes:

1. If the module is above these absolute maximum ratings. It may become permanently damaged. Using the module within the following electrical characteristic conditions are also exceeded, the module will malfunction and cause poor reliability.
2.  $V_{CC} > V_{SS}$  must be maintained.

### 6.2. Environment Conditions

Item	Symbol	MIN	MAX	Unit	Remark
Operating Temperature	TOPR	-20	70	°C	
Storage Temperature	TSTG	-30	80	°C	

Notes:

1. The response time will become lower when operated at low temperature.
2. Background color changes slightly depending on ambient temperature.  
The phenomenon is reversible.
3.  $T_a \leq 40^\circ\text{C}$ : 85%RH MAX.  
 $T_a \geq 40^\circ\text{C}$ : Absolute humidity must be lower than the humidity of 85%RH at  $40^\circ\text{C}$ .

## 7. Electrical Specifications

### 7.1 Electrical characteristics

GND=0V, Ta=25°C

Parameter	Symbol	Condition	Min	Typ	Max	Unit	Note	
Power supply for Analog	VCC	Ta=25°C	2.5	2.8	3.3	V		
Power supply for Logic	VDDI	Ta=25°C	1.65	2.8	3.3	V		
Input voltage	'H'	V <sub>IH</sub>	V <sub>CC</sub> =2.8V	0.8*V <sub>CC</sub>	-	V <sub>CC</sub>	V	
	'L'	V <sub>IL</sub>	V <sub>CC</sub> =2.8V	0	-	0.2*V <sub>CC</sub>	V	
Current Consumption	I <sub>CC1</sub>	Normal mode	-	10	15	mA	1	
	I <sub>CC2</sub>	Sleep mode	-	0.05	0.1	mA	1	

Note: Tested in 1×1 chessboard pattern.

### 7.2 LED Backlight

Ta=25°C

Item	Symbol	Condition	Min	Typ	Max	Unit	Note
Supply voltage	V <sub>f</sub>	I <sub>f</sub> =20x4mA	-	3.0	-	V	
Uniformity	ΔBp	I <sub>f</sub> =20x4mA	80			%	

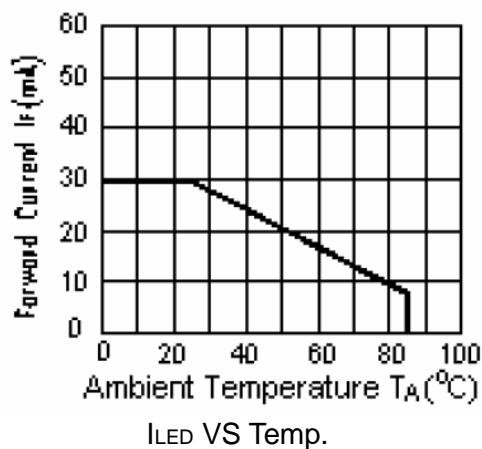

## 8. Command/AC Timing

### 8.1 CPU Interface Timing

Signal	Symbol	Parameter	Min	Max	Unit
RS	tast	Address setup time	0	-	ns
	taht	Address hold time(Write/Read)	10	-	ns
CS	tcs	Chip Select setup time(Write)	15	-	ns
	trcs	Chip Select setup time(Read)	45	-	ns
	tcsf	Chip Select Wait time(Write/Read)	10	-	ns
WR	twc	Write cycle	66	-	ns
	twrh	Write Control pulse H duration	15	-	ns
	twrl	Write Control pulse L duration	15	-	ns
RD	trc	Read cycle	160	-	ns
	trdh	Read Control pulse H duration	90	-	ns
	trdl	Read Control pulse L duration	45	-	ns
DB[17:0] DB[15:0] DB[8:0] DB[7:0]	twds	Write data setup time	10	-	ns
	twdh	Write data hold time	10	-	ns
	tracc	Read access time	-	340	ns
	trod	Read output disable time	20	80	ns

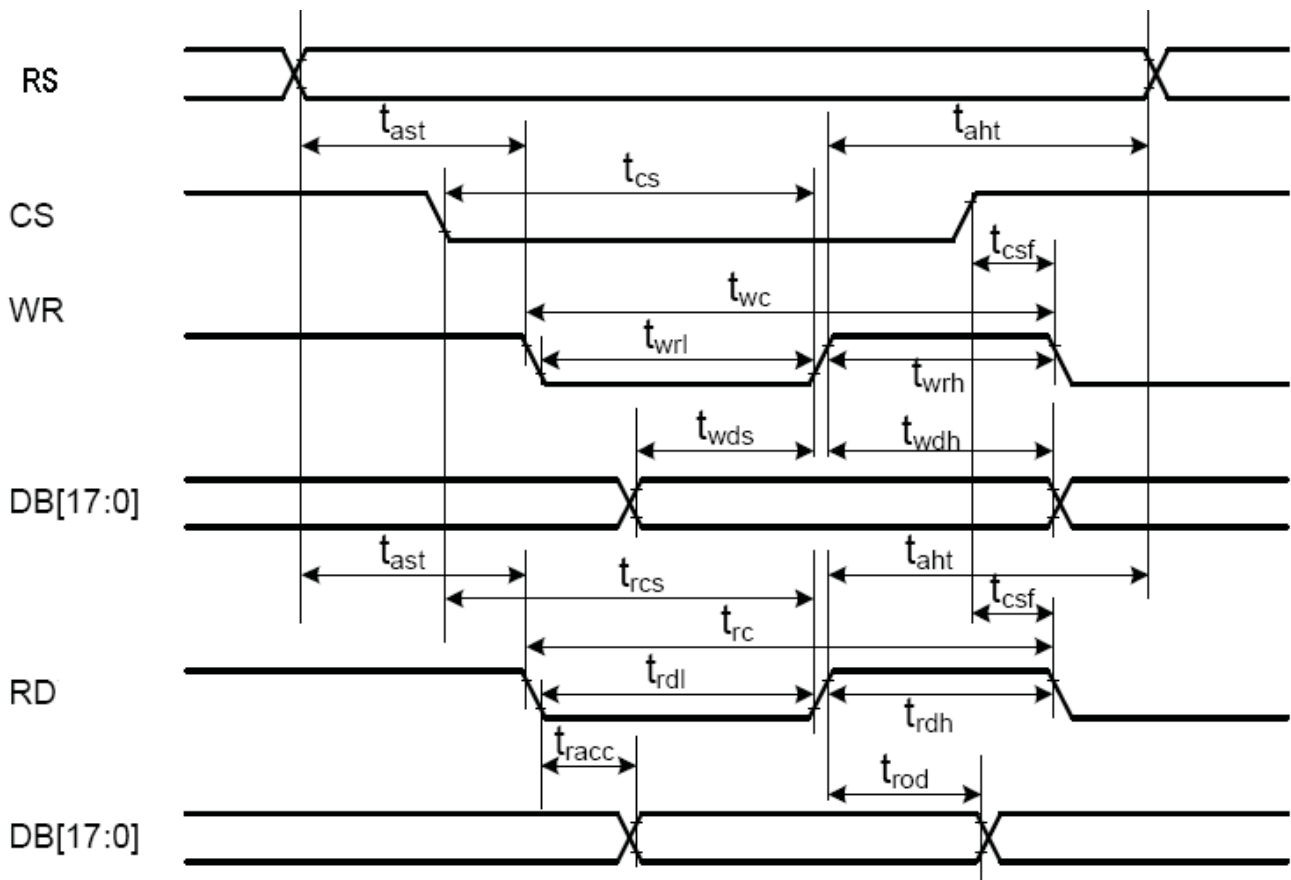



### 8.2 Reset Timing Characteristics

Item	Symbol	Min.	Typ.	Max.	Unit
RESET low-level width	tRES_L	1	-	-	ms
RESET rise time	trRES	-	-	10	s
Reset high-level width	tRES_H	50			ms

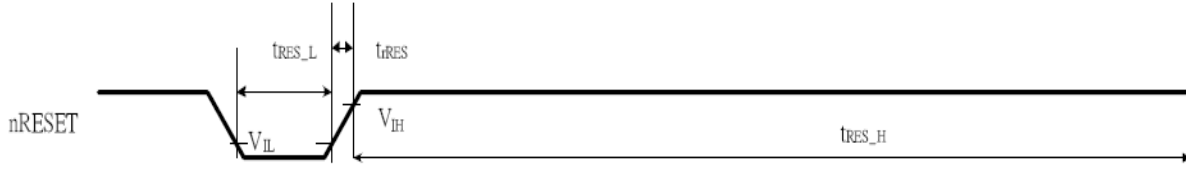

### 8.3 Power ON/Off Sequence

Power on

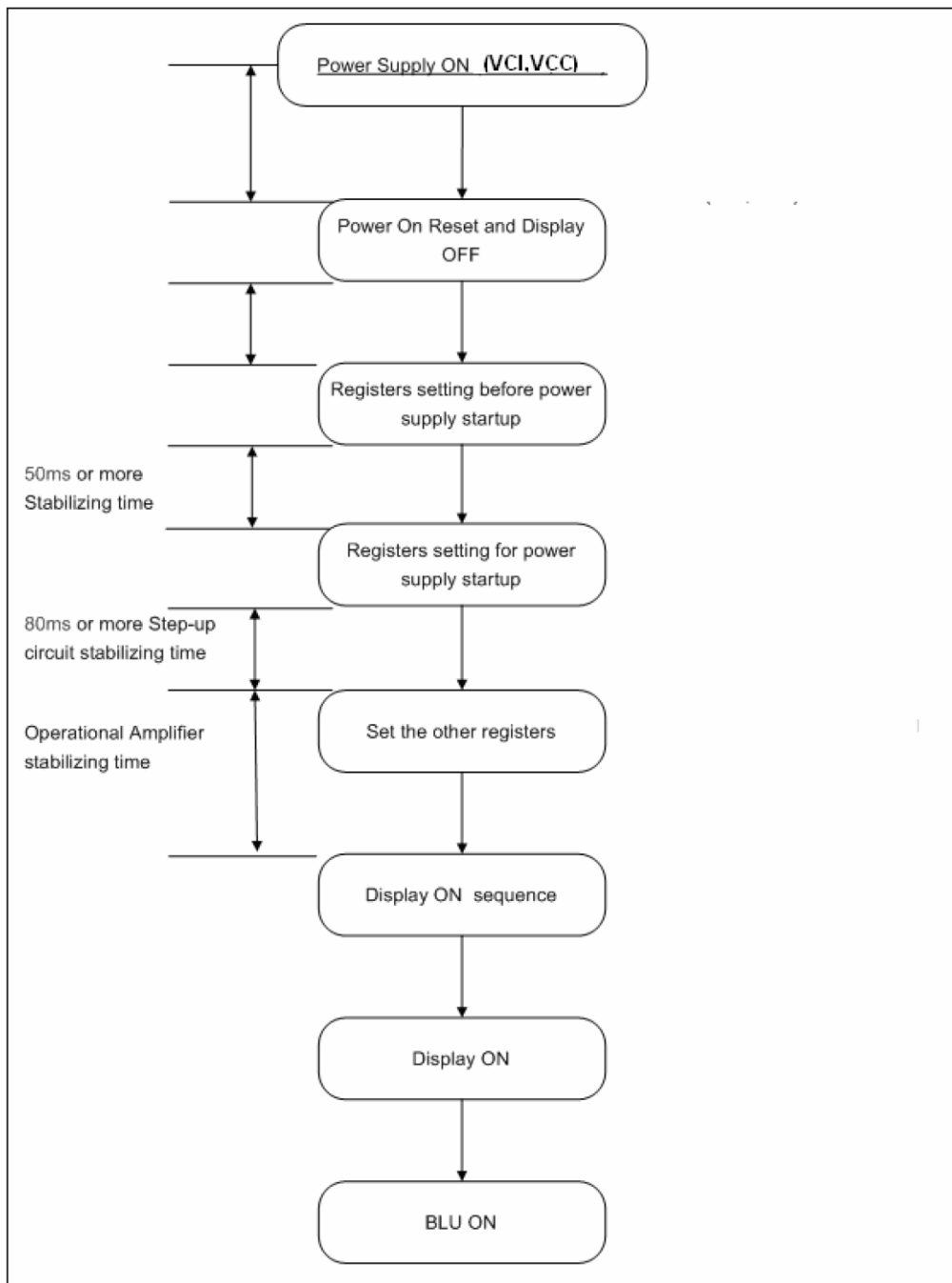

Power off

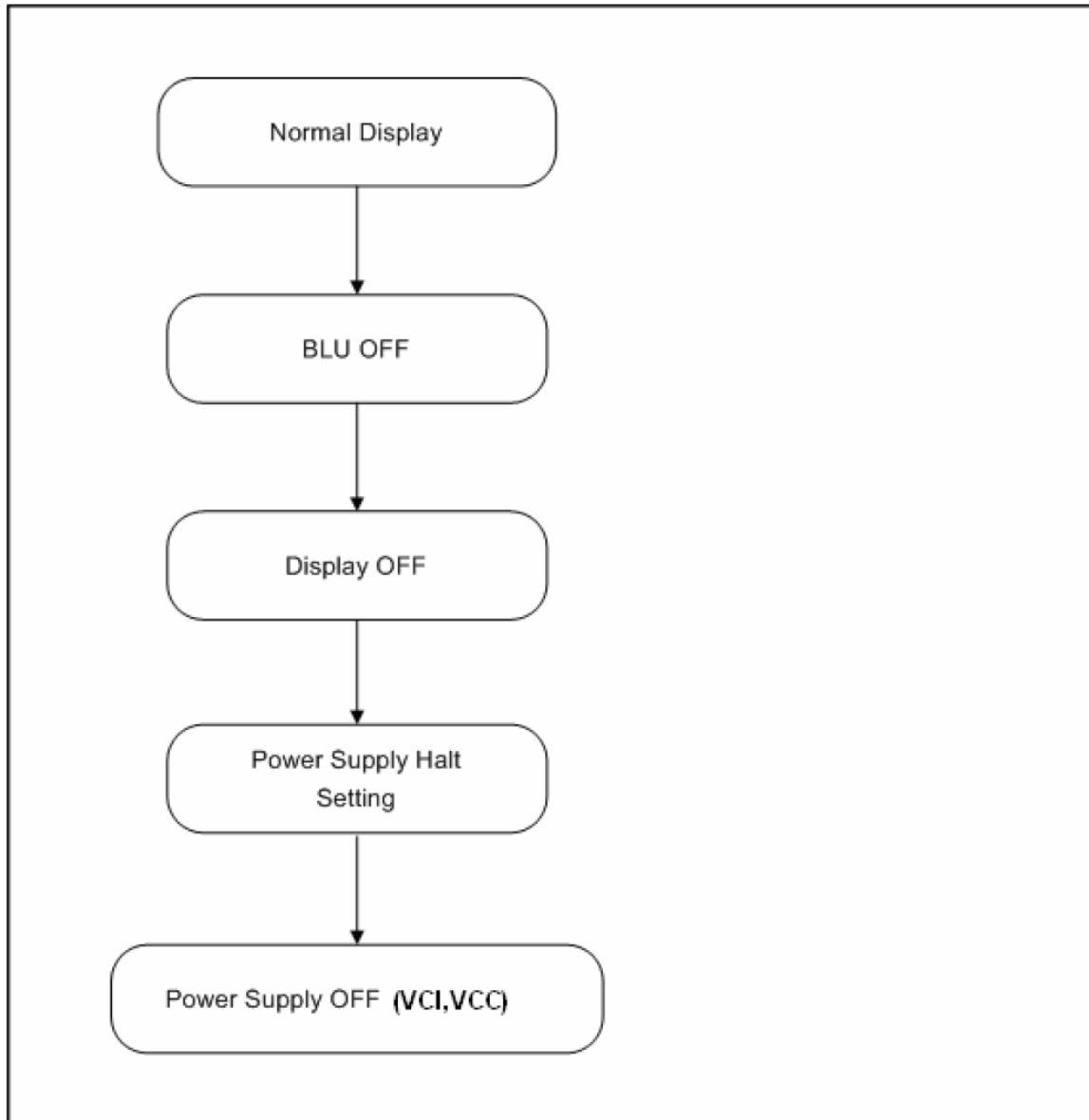

## 9. Optical Specification

Ta=25°C

Item	Symbol	Condition	Min	Typ.	Max.	Unit	Remark
Contrast Ratio	CR	$\theta=0^\circ$	300	500	-		Note1 Note2
Response Time	Tr	25°C	-	10	-	ms	Note1
	Tf		-	10	-	ms	Note3
View Angles	$\theta T$	$CR \geq 10$	-	55	-	Degree	Note 4
	$\theta B$		-	65	-		
	$\theta L$		-	65	-		
	$\theta R$		-	65	-		
Chromaticity	White	Brightness is on	x	-	0.33	-	Note5, Note1
			y	-	0.37	-	
	Red		x	-	0.51	-	
			y	-	0.34	-	
	Green		x	-	0.31	-	
			y	-	0.56	-	
	Blue		x	-	0.15	-	
			y	-	0.14	-	
NTSC	S		50	60	--	%	Note5
Luminance	L		--	350	--	cd/m <sup>2</sup>	Note1 Note6
Uniformity	U		80	-	--	%	Note1 Note7

Note 1: Definition of optical measurement system.

Temperature = 25°C(±3°C); LED back-light: ON, Environment brightness < 150 lx

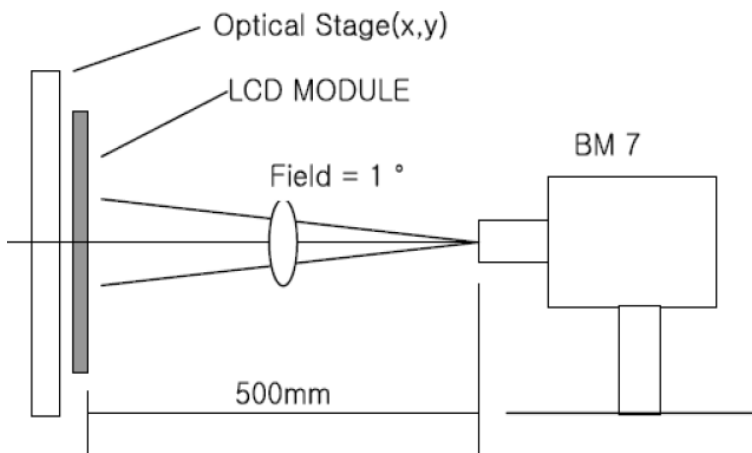

Note 2: Contrast ratio is defined as follow:

$$\text{Contrast Ratio} = \frac{\text{Surface Luminance with all white pixels}}{\text{Surface Luminance with all black pixels}}$$

Note 3: Response time is defined as follow:

Response time is the time required for the display to transition from black to white (Rise Time,  $T_r$ ) and from white to black (Decay Time,  $T_f$ ).

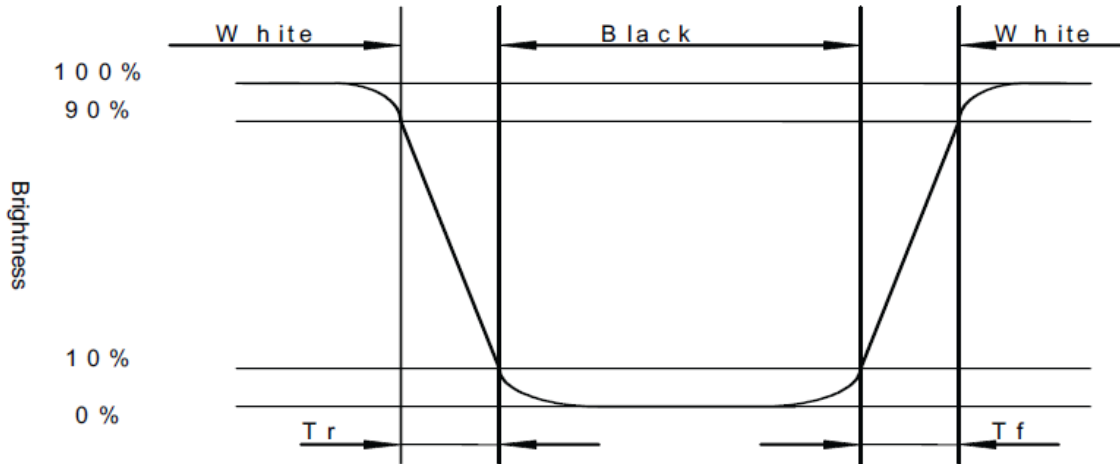

Note 4: Viewing angle range is defined as follow:

Viewing angle is measured at the center point of the LCD.

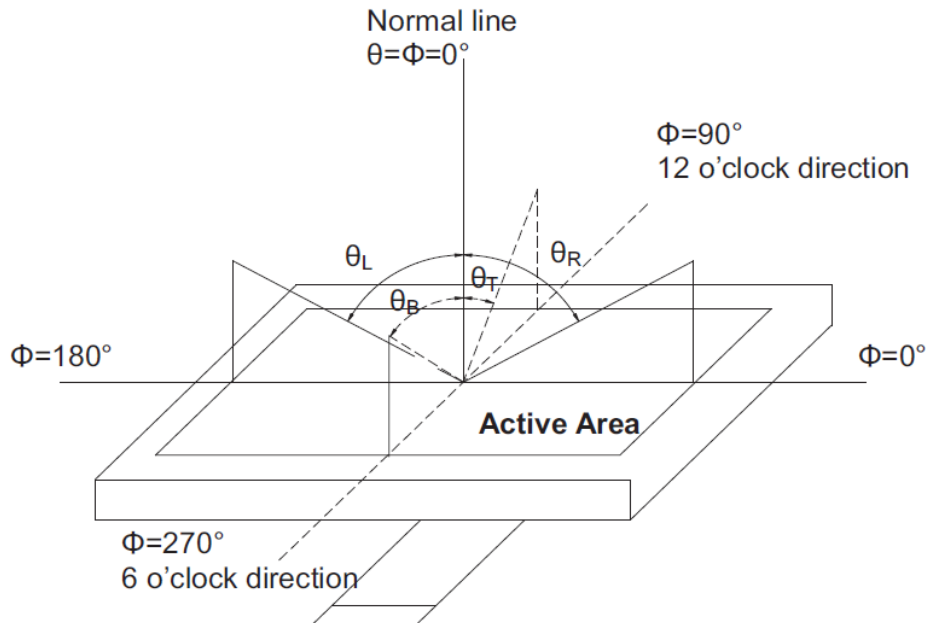

Note 5: Color chromaticity is defined as follow: (CIE1931)

Color coordinates measured at center point of LCD.

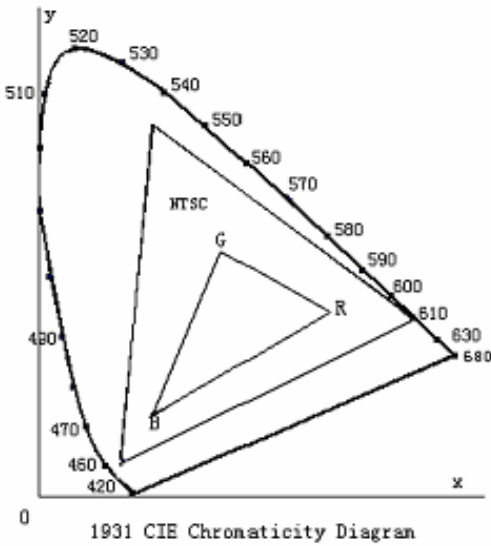

$$S = \frac{\text{area of RGB triangle}}{\text{area of NTSC triangle}} \times 100\%$$

Note 6: Luminance is defined as follow:

Luminance is defined as the brightness of all pixels “White” at the center of display area on optimum contrast.

Note 7: Luminance Uniformity is defined as follow:

Active area is divided into 9 measuring areas (Refer Fig. 2). Every measuring point is placed at the center of each measuring area.

$$\text{Uniformity}(U) = \frac{\text{Minimum Luminance(brightness) in 9 points}}{\text{Maximum Luminance(brightness) in 9 points}}$$

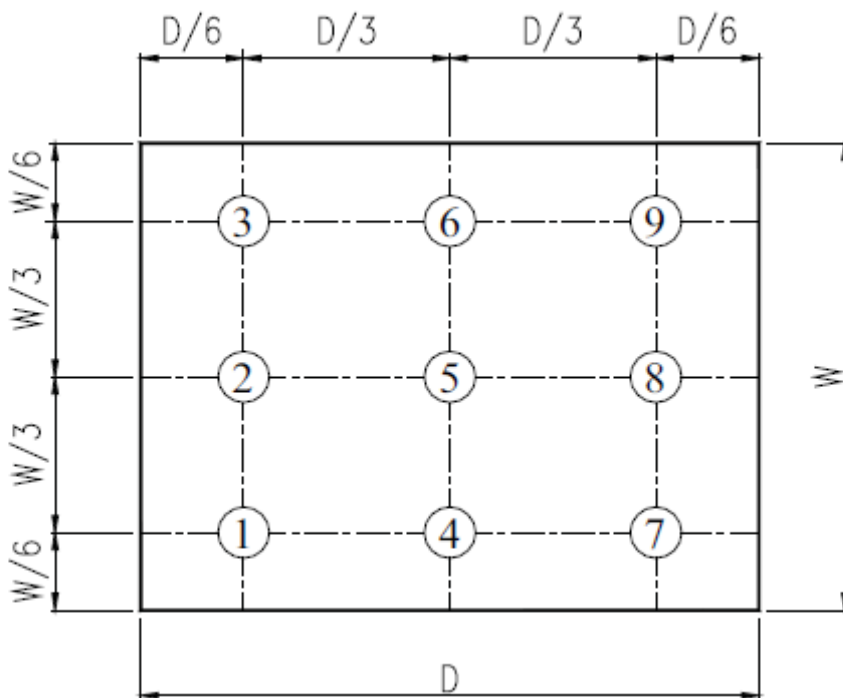

Fig. 2 Definition of uniformity

## 10. Environmental / Reliability Tests

No	Test Item	Condition	Judgment criteria
1	High Temp Operation	Ts=+70°C, 96hrs	Per table in below
2	Low Temp Operation	Ta=-20°C, 96hrs	Per table in below
3	High Temp Storage	Ta=+80°C, 96hrs	Per table in below
4	Low Temp Storage	Ta=-30°C, 96hrs	Per table in below
5	High Temp & High Humidity Storage	Ta=+40°C, 90% RH 96 hours	Per table in below (polarizer discoloration is excluded)
6	Thermal Shock (Non-operation)	-30°C 30 min~+80°C 30 min, Change time:5min, 5 Cycles	Per table in below
7	ESD (Operation)	C=150pF, R=330Ω · 5points/panel Air:±8KV, 5times; Contact:±4KV, 5 times;	Per table in below
8	Vibration (Non-operation)	10Hz~150Hz, 100m/s <sup>2</sup> , 120min	Per table in below
9	Shock (Non-operation)	Half- sine wave,300m/s <sup>2</sup> ,11ms	Per table in below
10	Package Drop Test	Height:80 cm, 1 corner, 3 edges, 6 surfaces	Per table in below

INSPECTION	CRITERION(after test)
Appearance	No Crack on the FPC, on the LCD Panel
Alignment of LCD Panel	No Bubbles in the LCD Panel No other Defects of Alignment in Active area
Electrical current	Within device specifications
Function / Display	No Broken Circuit, No Short Circuit or No Black line No Other Defects of Display

## 11. Precautions for Use of LCD Modules

### 11.1 Safety

The liquid crystal in the LCD is poisonous. Do not put it in your mouth. If the liquid crystal touches your skin or clothes, wash it off immediately using soap and water.

### 11.2 Handling

- A. The LCD and touch panel is made of plate glass. Do not subject the panel to mechanical shock or to excessive force on its surface.
- B. Do not handle the product by holding the flexible pattern portion in order to assure the reliability
- C. Transparency is an important factor for the touch panel. Please wear clear finger sacks, gloves and mask to protect the touch panel from finger print or stain and also hold the portion outside the view area when handling the touch panel.
- D. Provide a space so that the panel does not come into contact with other components.
- E. To protect the product from external force, put a covering lens (acrylic board or similar board) and keep an appropriate gap between them.
- F. Transparent electrodes may be disconnected if the panel is used under environmental conditions where dew condensation occurs.
- G. Property of semiconductor devices may be affected when they are exposed to light, possibly resulting in IC malfunctions.
- H. To prevent such IC malfunctions, your design and mounting layout shall be done in the way that the IC is not exposed to light in actual use.

### 11.3 Static Electricity

- A. Ground soldering iron tips, tools and testers when they are in operation.
- B. Ground your body when handling the products.
- C. Power on the LCD module before applying the voltage to the input terminals.
- D. Do not apply voltage which exceeds the absolute maximum rating.
- E. Store the products in an anti-electrostatic bag or container.

### 11.4 Storage

- A. Store the products in a dark place at  $+25^{\circ}\text{C} \pm 10^{\circ}\text{C}$  with low humidity (40% RH to 60% RH). Don't expose to sunlight or fluorescent light.
- B. Storage in a clean environment, free from dust, active gas, and solvent.

### 11.5 Cleaning

- A. Do not wipe the touch panel with dry cloth, as it may cause scratch.
- B. Wipe off the stain on the product by using soft cloth moistened with ethanol. Do not allow ethanol to get in between the upper film and the bottom glass. It may cause peeling issue or defective operation. Do not use any organic solvent or detergent other than ethanol.

### 11.6 Cautions for installing and assembling

Bezel edge must be positioned in the area between the Active area and View area. The bezel may press the touch screen and cause activation if the edge touches the active area. A gap of approximately 0.5mm is needed between the bezel and the top electrode. It may cause unexpected activation if the gap is too narrow. There is a tolerance of 0.2 to 0.3mm for the outside dimensions of the touch panel and tail. A gap must be made to absorb the tolerance in the case and connector.

