

**DLC Display Co., Limited**

德爾西顯示器有限公司



MODEL No: DLC0347BBP06CF-1

TEL: 86-755-86029824

FAX: 86-755-86029827

E-MAIL: [sales@dlcdisplay.com](mailto:sales@dlcdisplay.com)

WEB: [www.dlcdisplay.com](http://www.dlcdisplay.com)



### Record of Revision

Date	Revision No.	Summary
2018-10-19	1.0	Rev 1.0 was issued

### 1. Scope

This data sheet is to introduce the specification of DLC0347BBP06CF-1 active matrix TFT module. It is composed of a color TFT-LCD panel, driver IC, FPC and a backlight unit. The 3.47" display area contains 320(RGB) x 480 pixels.

### 2. Application

Digital equipments which need color display, mobile navigator/video systems.

### 3. General Information

Item	Contents	Unit
Size	3.47	inch
Resolution	320(RGB) x 480	/
Display Color	65K	
Interface	MCU-16bit	/
Technology type	IPS	/
Pixel Configuration	R.G.B. Vertical Stripe	
Outline Dimension (W x H x D)	54.66 x 82.94 x 2.35	mm
Active Area	48.96 x 73.44	mm
Display Mode	Transmissive	/
View Direction	All	O'clock
Backlight Type	LED	/
Driver IC	ILI9488	/
Weight	TBD	g

### 4. Outline Drawing

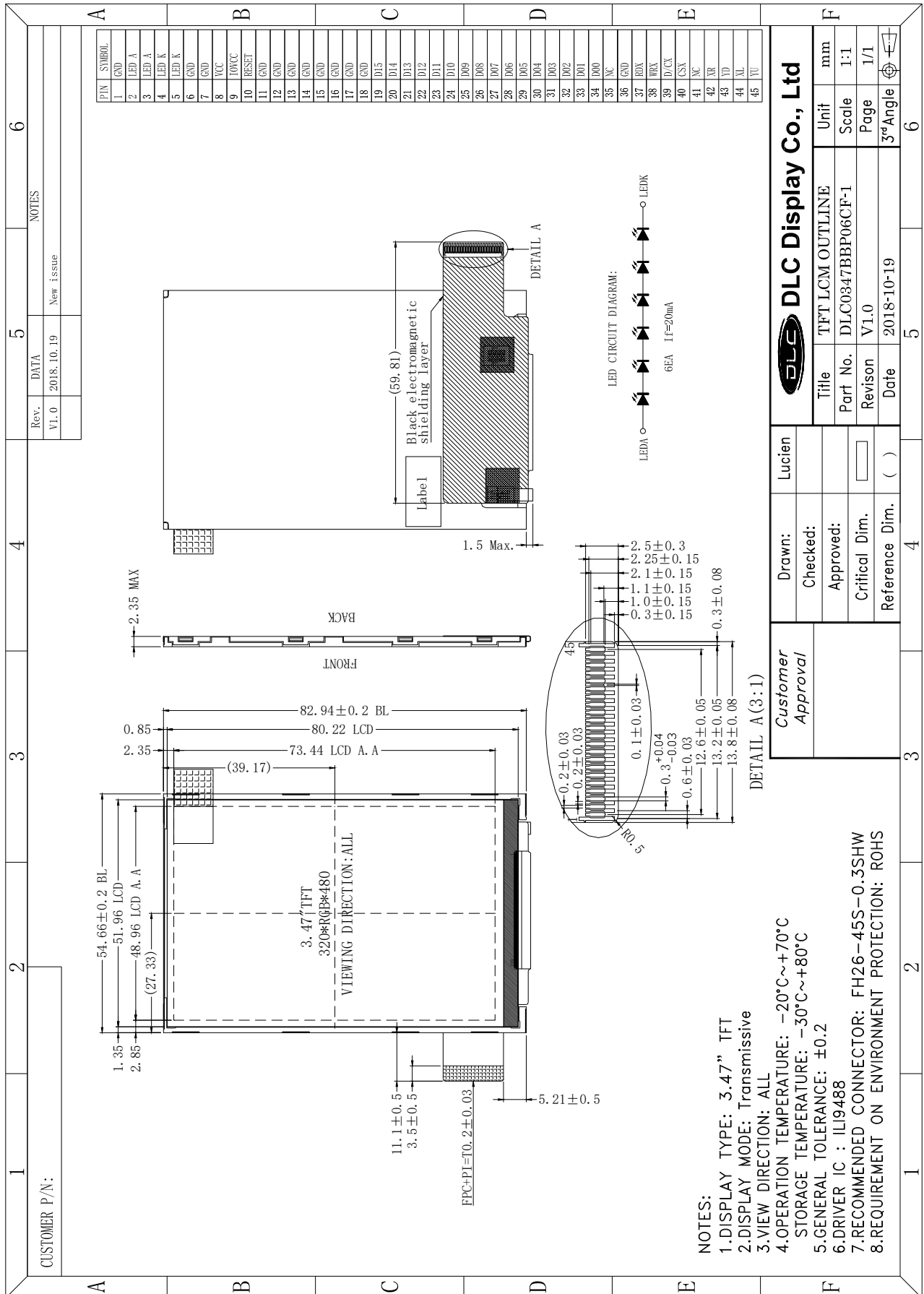

## 5. Interface signals

Pin No.	Symbol	I/O	Function
1	GND	P	Ground.
2	LEDA	P	LED backlight (Anode)
3	LEDA	P	LED backlight (Anode)
4	LEDK	P	LED backlight (Cathode)
5	LEDK	P	LED backlight (Cathode)
6	GND	P	Ground.
7	GND	P	Ground.
8	VCC	P	Power supply
9	IOVCC	P	Digital I/O Pad power supply
10	RESET	I	Reset the display
11-18	GND	P	Ground.
19-34	D15-D00	I/O	Data bus
35	NC	-	No connection
36	GND	P	Ground
37	RDX	I	Serves as a read signal
38	WRX	I	Serves as a write signal
39	D/CX	I	Data/Command Selection pin
40	CSX	I	Chip select signal
41	NC	-	No connection
42	XR	O	Touch Panel Control pin ( IF WITH TP)
43	YD	O	
44	XL	O	
45	YU	O	

Connector: FH26-45S-0.3SHW

## 6. Absolute maximum Ratings

### 6.1. Electrical Absolute max. ratings

Item	Symbol	MIN	MAX	Unit	Remark
Power Supply Voltage	V <sub>CC</sub>	-0.3	4.6	V	1, 2
Logic Signal Input /Output Voltage	V <sub>IOVCC</sub>	-0.3	4.6	V	

Note1: If the module is above these absolute maximum ratings. It may become permanently damaged. Using the module within the following electrical characteristic conditions are also exceeded, the module will malfunction and cause poor reliability.

Note2: VCC > VSS must be maintained.

## 6.2. Environment Conditions

Item	Symbol	MIN	MAX	Unit	Remark
Operating Temperature	TOPR	-20	70	°C	
Storage Temperature	TSTG	-30	80	°C	

Note1: The response time will become lower when operated at low temperature.

Note2: Background color changes slightly depending on ambient temperature.

The phenomenon is reversible.

Note3:  $T_a \leq 40^\circ\text{C}$ : 85%RH MAX.

$T_a > 40^\circ\text{C}$ : Absolute humidity must be lower than the humidity of 85%RH at  $40^\circ\text{C}$ .

## 7. Electrical Specifications

### 7.1 Electrical characteristics

Parameter	Symbol	Condition	Min	Typ	Max	Unit	Note
Power supply	VCC	$T_a = 25^\circ\text{C}$	2.6	2.8	3.3	V	
I/O operating voltage	IOVCC	$T_a = 25^\circ\text{C}$	1.65	1.8	3.3		
Input voltage	'H'	$V_{CC} = 2.8\text{V}$	$0.8 \cdot V_{CC}$	-	$V_{CC}$	V	
	'L'	$V_{CC} = 2.8\text{V}$	0	-	$0.2 \cdot V_{CC}$	V	

### 7.2 LED Backlight

Item	Symbol	Min	Typ	Max	Unit	Note
Supply voltage	Vf	-	18	-	V	If=20mA
Supply current	If	-	20	-	mA	
LED life time	-	20,000	(30,000)	-	Hrs	

Note: The "LED life time" is defined as the module brightness decrease to 50% original brightness at  $T_a = 25^\circ\text{C}$  and  $I_L = 20\text{mA}$ . The LED lifetime could be decreased if operating  $I_L$  is larger than 20mA

LED CIRCUIT DIAGRAM:

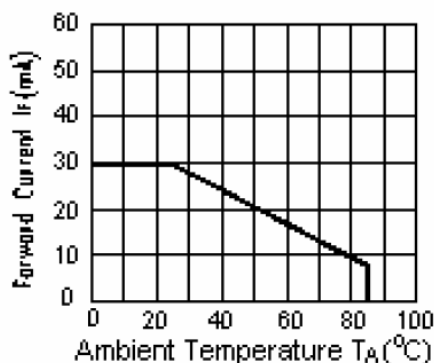
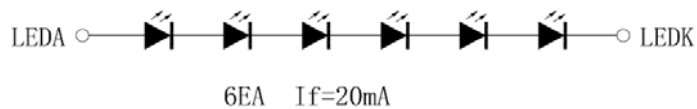

$I_{LED}$  VS TEMP

## 8. Command/AC Timing

### 8.1 AC Characteristics

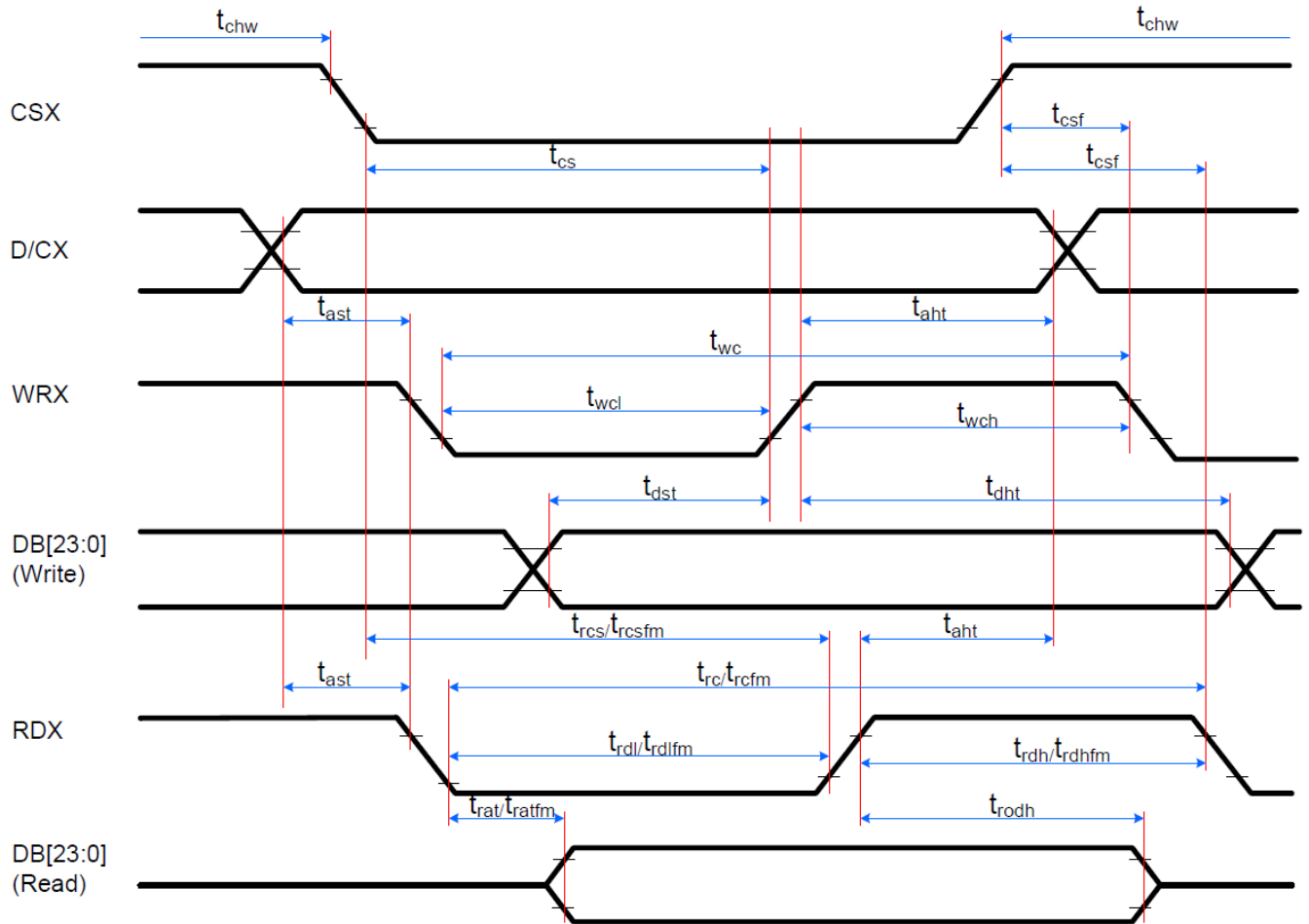

Signal	Symbol	Parameter	Min.	Max.	Unit	Description
DCX	tast	Address setup time	0	-	ns	
	that	Address hold time(write/read)	0	-	ns	
CSX	tchw	CSX "H" pulse width	0	-	ns	
	tcs	Chip select setup time (write)	15	-	ns	
	trcs	Chip select setup time (read time)	45	-	ns	
	trcsfm	Chip select setup time (read FM)	355	-	ns	
	tcsf	Chip select wait time (write/read)	0	-	ns	
WRX	twc	Write cycle	40	-	ns	
	twrh	Write control pulse H duration	15	-	ns	
	twrl	Write control pulse L duration	15	-	ns	
RDX(FM)	trcfm	Read cycle (FM)	450	-	ns	When read from frame memory
	trdhfm	Read control H duration (FM)	90	-	ns	
	trdlfm	Read control L duration (FM)	355	-	ns	
RDX(ID)	trc	Read cycle (ID)	160	-	ns	

	trdh	Read control pulse H duration	90	-	ns	when read ID data
	trdl	Read control pulse L duration	45	-	ns	
DB[23:0] DB[17:0] DB[15:0] DB[8:0] DB[7:0]	tdst	Write data setup time	10	-	ns	For maximum, CL=30pF For minimum, CL=8pF
	tdht	Write data hold time	10	-	ns	
	trat	Read access time	-	40	ns	
	tratfm	Read access time	-	340	ns	
	trod	Read output disable time	20	80	ns	

Note1: Ta = -30 to 70 °C, IOVCC = 1.65V to 3.3V, VCI = 2.5V to 3.3V, AGND = DGND = 0V

Note2: Logic high and low levels are specified as 30% and 70% of IOVCC for input signals.

Note3: Input signal rising time and falling time:

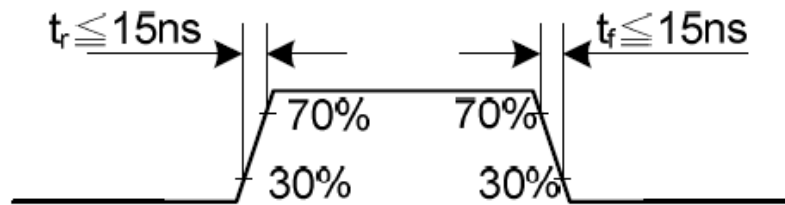

Note4: The CSX timing:

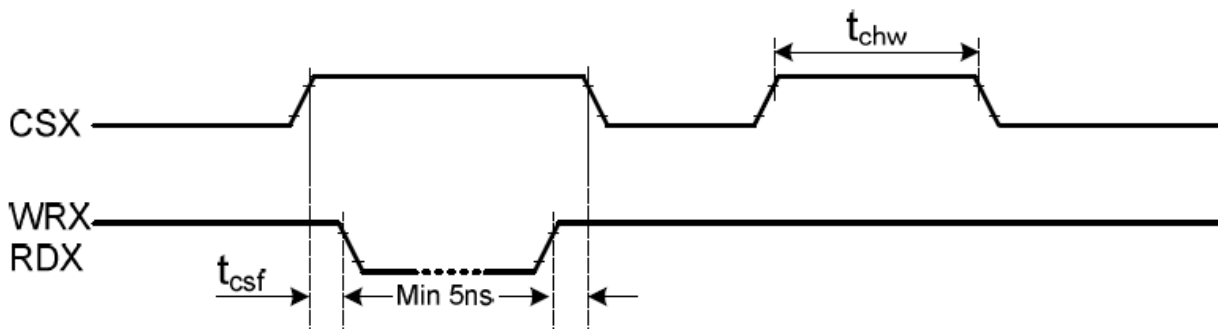

Note5: The Write to Read or the Read to Write timing:

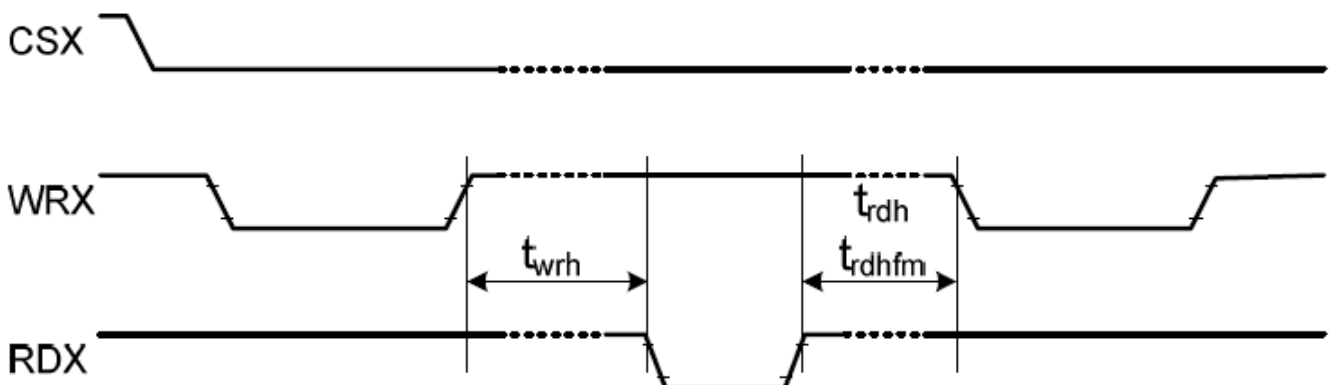



## 9. Optical Specification

Ta=25°C

Item	Symbol	Condition	Min	Typ.	Max.	Unit	Remark
Contrast Ratio	CR	$\theta=0^\circ$	600	800	-		Note1 Note2
Response Time	Tr	25°C	-	25	-	ms	Note1
	Tf		-	25	-	ms	Note3
View Angles	$\theta T$	$CR \geq 10$	-	80	-	Degree	Note 4
	$\theta B$		-	80	-		
	$\theta L$		-	80	-		
	$\theta R$		-	80	-		
Chromaticity	White	x	-	0.30	-	Note5, Note1	
		y	-	0.33	-		
	Red	x	-	0.63	-		
		y	-	0.33	-		
	Green	x	-	0.28	-		
		y	-	0.55	-		
	Blue	x	-	0.14	-		
		y	-	0.12	-		
Luminance	L		--	300	--	cd/m <sup>2</sup>	Note1 Note6
Uniformity	U		80	--	--	%	Note1 Note7

Note 1: Definition of optical measurement system.

Temperature = 25°C(±3°C); LED back-light: ON, Environment brightness < 150 lx

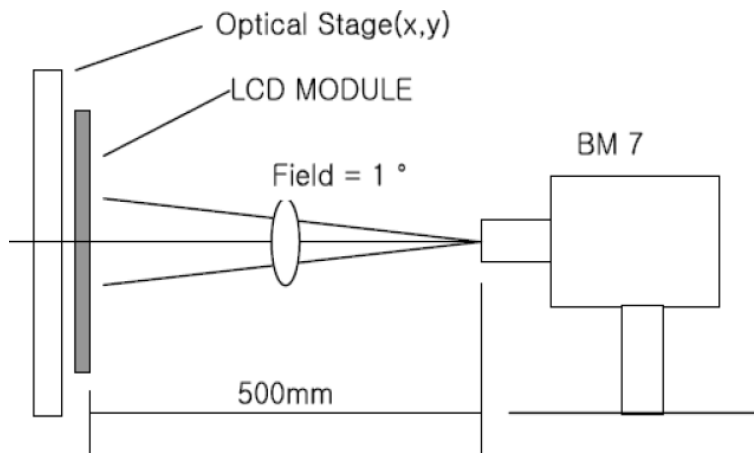

Note 2: Contrast ratio is defined as follow:

$$\text{Contrast Ratio} = \frac{\text{Surface Luminance with all white pixels}}{\text{Surface Luminance with all black pixels}}$$

Note 3: Response time is defined as follow:

Response time is the time required for the display to transition from black to white (Rise Time,  $T_r$ ) and from white to black (Decay Time,  $T_f$ ).

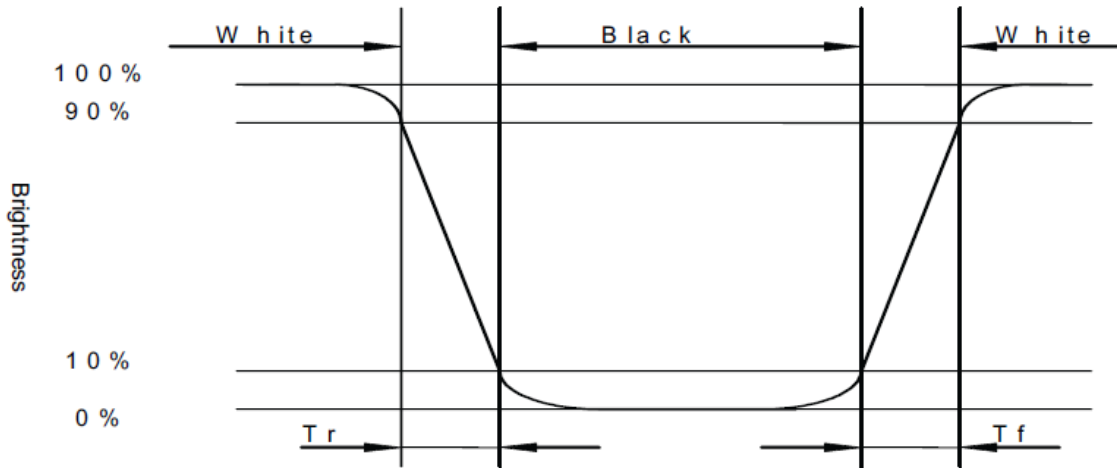

Note 4: Viewing angle range is defined as follow:

Viewing angle is measured at the center point of the LCD.

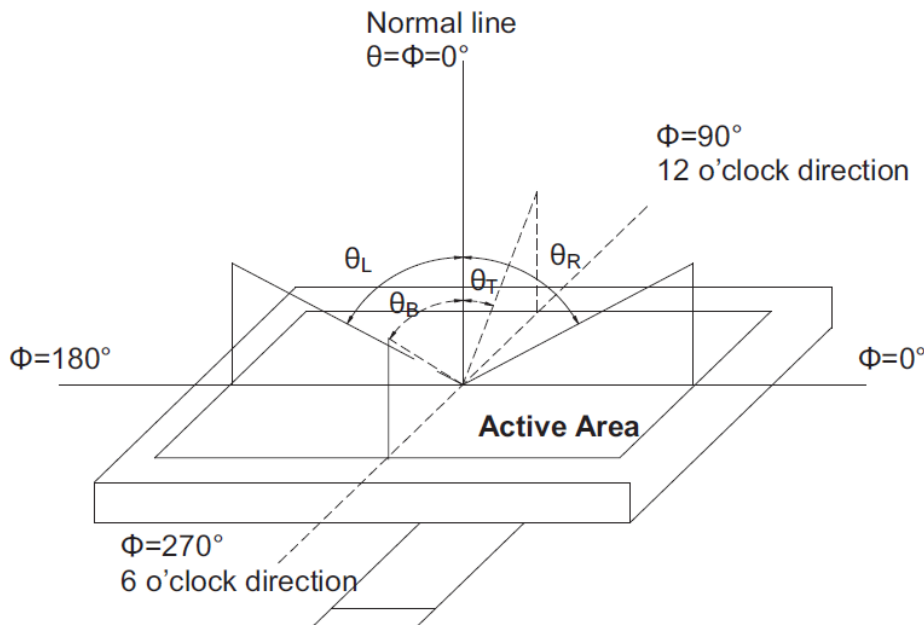

Note 5: Color chromaticity is defined as follow: (CIE1931)

Color coordinates measured at center point of LCD.

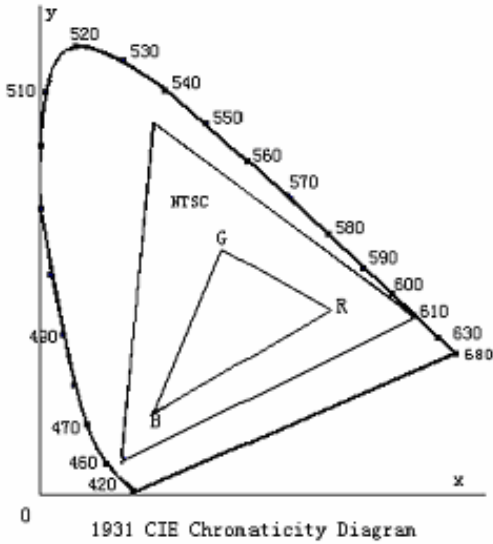

$$S = \frac{\text{area of RGB triangle}}{\text{area of NTSC triangle}} \times 100\%$$

Note 6: Luminance is defined as follow:

Luminance is defined as the brightness of all pixels “White” at the center of display area on optimum contrast.

Note 7: Luminance Uniformity is defined as follow:

Active area is divided into 9 measuring areas (Refer Fig. 2). Every measuring point is placed at the center of each measuring area.

$$\text{Uniformity (U)} = \frac{\text{Minimum Luminance( brightness ) in 9 points}}{\text{Maximum Luminance( brightness ) in 9 points}}$$

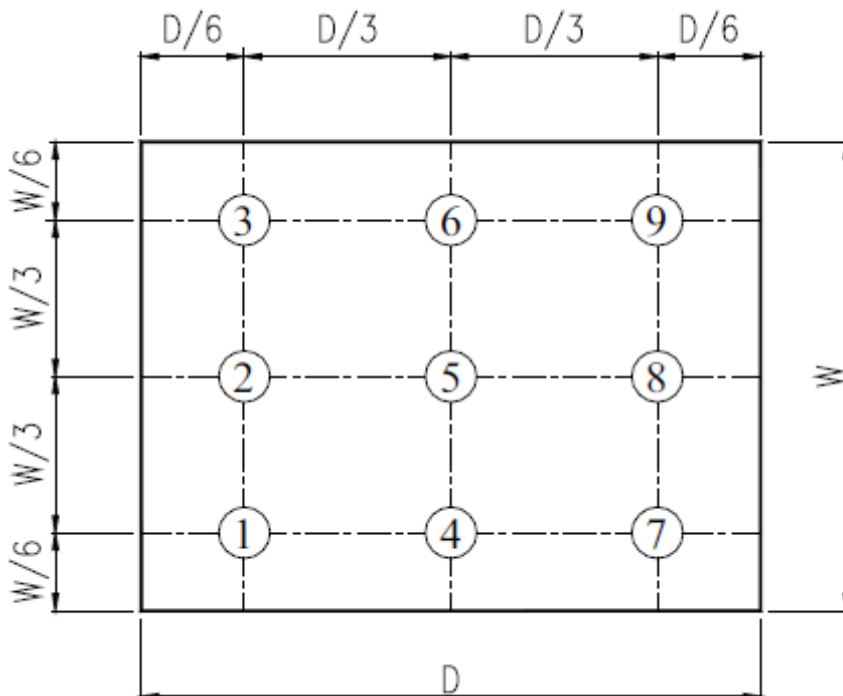

Fig. 2 Definition of uniformity

## 10. Environmental / Reliability Tests

No	Test Item	Condition	Judgment criteria
1	High Temp Operation	Ts=+70°C, 96hrs	Per table in below
2	Low Temp Operation	Ta=-20°C, 96hrs	Per table in below
3	High Temp Storage	Ta=+80°C, 96hrs	Per table in below
4	Low Temp Storage	Ta=-30°C, 96hrs	Per table in below
5	High Temp & High Humidity Storage	Ta=+60°C, 90% RH 96 hours	Per table in below (polarizer discoloration is excluded)
6	Thermal Shock (Non-operation)	-30°C 30 min~+80°C 30 min, Change time:5min, 5 Cycles	Per table in below
7	ESD (Operation)	C=150pF, R=330Ω , 5points/panel Air:±8KV, 5times; Contact:±4KV, 5 times;	Per table in below
8	Vibration (Non-operation)	10Hz~150Hz, 100m/s <sup>2</sup> , 120min	Per table in below
9	Shock (Non-operation)	Half- sine wave,300m/s <sup>2</sup> ,11ms	Per table in below
10	Package Drop Test	Height:80 cm, 1 corner, 3 edges, 6 surfaces	Per table in below

INSPECTION	CRITERION(after test)
Appearance	No Crack on the FPC, on the LCD Panel
Alignment of LCD Panel	No Bubbles in the LCD Panel No other Defects of Alignment in Active area
Electrical current	Within device specifications
Function / Display	No Broken Circuit, No Short Circuit or No Black line No Other Defects of Display

## 11. Precautions for Use of LCD Modules

### 11.1 Safety

The liquid crystal in the LCD is poisonous. Do not put it in your mouth. If the liquid crystal touches your skin or clothes, wash it off immediately using soap and water.

### 11.2 Handling

- A. The LCD and touch panel is made of plate glass. Do not subject the panel to mechanical shock or to excessive force on its surface.
- B. Do not handle the product by holding the flexible pattern portion in order to assure the reliability
- C. Transparency is an important factor for the touch panel. Please wear clear finger sacks, gloves and mask to protect the touch panel from finger print or stain and also hold the portion outside the view area when handling the touch panel.
- D. Provide a space so that the panel does not come into contact with other components.
- E. To protect the product from external force, put a covering lens (acrylic board or similar board) and keep an appropriate gap between them.
- F. Transparent electrodes may be disconnected if the panel is used under environmental conditions where dew condensation occurs.
- G. Property of semiconductor devices may be affected when they are exposed to light, possibly resulting in IC malfunctions.
- H. To prevent such IC malfunctions, your design and mounting layout shall be done in the way that the IC is not exposed to light in actual use.

### 11.3 Static Electricity

- A. Ground soldering iron tips, tools and testers when they are in operation.
- B. Ground your body when handling the products.
- C. Power on the LCD module before applying the voltage to the input terminals.
- D. Do not apply voltage which exceeds the absolute maximum rating.
- E. Store the products in an anti-electrostatic bag or container.

### 11.4 Storage

- A. Store the products in a dark place at  $+25^{\circ}\text{C} \pm 10^{\circ}\text{C}$  with low humidity (40% RH to 60% RH). Don't expose to sunlight or fluorescent light.
- B. Storage in a clean environment, free from dust, active gas, and solvent.

### 11.5 Cleaning

- A. Do not wipe the touch panel with dry cloth, as it may cause scratch.
- B. Wipe off the stain on the product by using soft cloth moistened with ethanol. Do not allow ethanol to get in between the upper film and the bottom glass. It may cause peeling issue or defective operation. Do not use any organic solvent or detergent other than ethanol.

### 11.6 Cautions for installing and assembling

- A. Bezel edge must be positioned in the area between the Active area and View area. The bezel may press the touch screen and cause activation if the edge touches the active area. A gap of approximately 0.5mm is needed between the bezel and the top electrode. It may cause unexpected activation if the gap is too narrow. There is a tolerance of 0.2 to 0.3mm for the outside dimensions of the touch panel and tail. A gap must be made to absorb the tolerance in the case and connector.
- B. In order to make the display assembly stable and firm, DLC recommends to design some supporting at the display backside, especially for the display with tape-attached touch panel, such supporting is important and essential, or else, the display may drop-off from front after some period of time.
- C. Do not display the fixed pattern for a long time because it may develop image sticking due to the LCD structure. If the screen is displayed with fixed pattern, use a screen saver.

