

For main power supplies  
Cycle life type

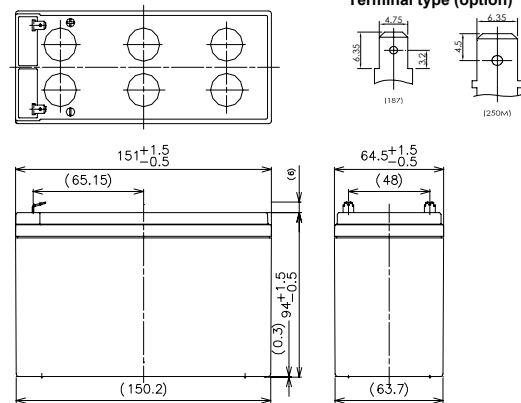

### ■ Dimensions(mm)



Battery case resin: standard(UL94HB)

※Contents indicated (including the recycle marking, etc) are subject to change without notice.

### ■ Specifications

Nominal Voltage		12V
Rated Capacity(20HR)		7.2Ah
Dimensions	Length	151 mm
	Width	64.5 mm
	Height	94 mm
	Total height	100 mm
Approx. Mass		2.45 kg
Terminal		Faston 187 & 250M

### ■ Characteristics

Capacity (25 °C)	20 hour rate	7.2Ah
	10 hour rate	6.5Ah
	3 hour rate	5.8Ah
	1 hour rate	4.9Ah
Internal Resistance (25 °C)	Fully charged battery	27.5 mΩ
Temperature Dependency of Capacity (20 hour rate)	40 °C	102%
	25 °C	100%
	0 °C	85%
	-15 °C	65%
Self Discharge (25 °C)	After 3 months	91%
	After 6 months	82%
	After 12 months	64%

### ■ Duration of discharge vs. discharge current

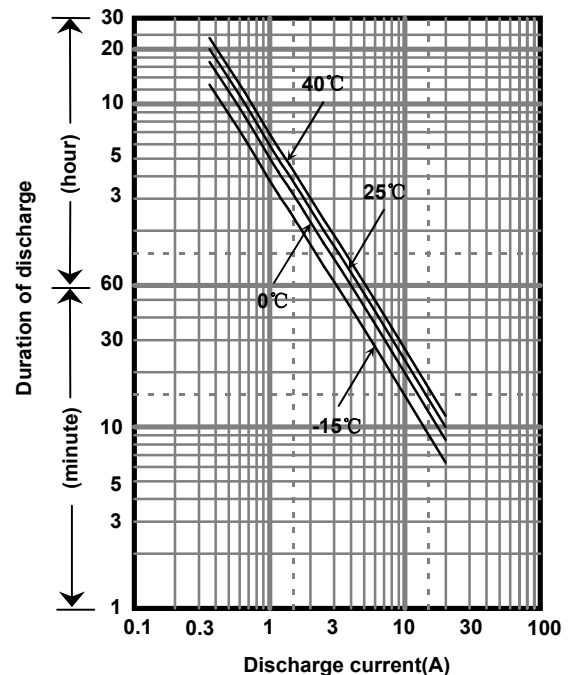

### ■ Watt Table(25°C)

Wattage values in the table are average instead of guaranteed value, please consider appropriate redundancy by application.

(Wattage/Battery)

Cut-off V	3min	5min	10min	15min	20min	30min	45min	1h	1.5h	2h	3h	4h	5h	6h	10h	20h
9.6V	430	335	220	167	134	98.4	72.1	56.5	44.6	34.7	24.7	19.2	15.4	12.8	8.39	4.60
9.9V	405	287	187	159	130	96.4	71.6	55.1	43.7	34.4	24.5	19.1	15.3	12.5	8.35	4.59
10.2V	379	273	182	151	126	94.3	68.6	53.6	41.4	32.5	23.5	18.7	14.6	12.2	8.00	4.43
10.5V	343	248	174	144	120	90.8	66.8	52.4	39.8	31.5	23.0	18.3	14.5	12.1	7.96	4.42
10.8V	308	223	164	138	115	87.2	62.6	48.4	37.2	28.1	21.4	16.9	13.3	11.2	7.41	4.13

### ■ Ampere Table(25°C)

Ampere values in the table are average instead of guaranteed value, please consider appropriate redundancy by application.

(Ampere/Battery)

Cut-off V	3min	5min	10min	15min	20min	30min	45min	1h	1.5h	2h	3h	4h	5h	6h	10h	20h
9.6V	38.9	30.6	19.9	14.8	12.3	9.10	6.40	5.10	3.50	2.70	2.00	1.53	1.26	1.02	0.670	0.363
9.9V	36.1	28.7	19.5	14.7	12.1	9.00	6.36	5.05	3.43	2.68	1.99	1.52	1.25	1.01	0.667	0.362
10.2V	34.2	26.9	19.0	14.4	11.9	8.90	6.30	5.00	3.36	2.61	1.97	1.51	1.24	1.00	0.660	0.361
10.5V	31.4	24.1	17.6	13.4	11.3	8.70	6.20	4.90	3.29	2.52	1.94	1.50	1.23	0.988	0.657	0.360
10.8V	29.0	22.3	15.7	12.5	11.0	8.40	6.10	4.80	3.20	2.40	1.90	1.48	1.20	0.972	0.650	0.358

**Charging Method (25°C)**

Cycle use	Control voltage: 14.5-14.9V Initial current: 2.88A or smaller
-----------	--

**Cut off voltage**

Discharge current	0.360A-1.44A	1.44A-3.60A	3.60A-7.20A	7.20A-14.4A	14.4A-21.6A
Cut off voltage(V)	10.5	10.2	9.9	9.3	8.7

**Cycle life vs. Depth of discharge**

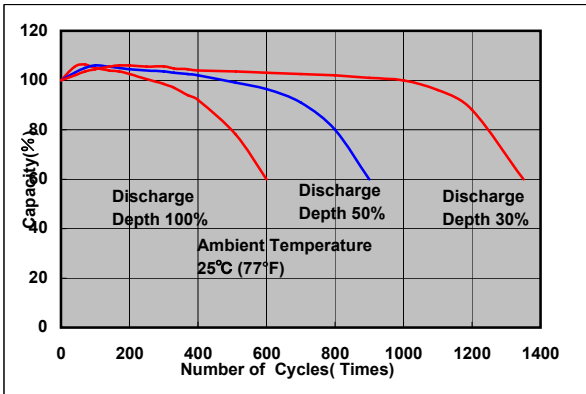

**Residual capacity test result**

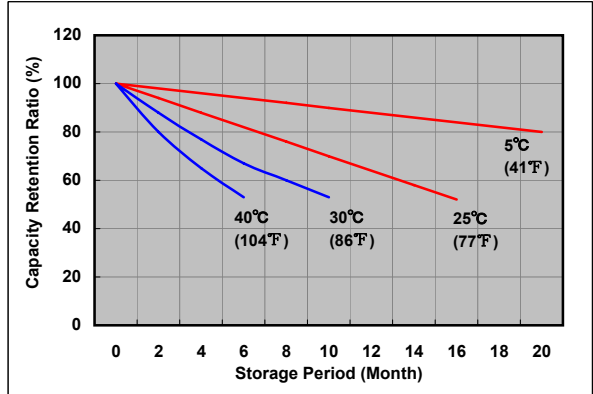

**Constant-voltage constant-current charge characteristics for Cycle use**

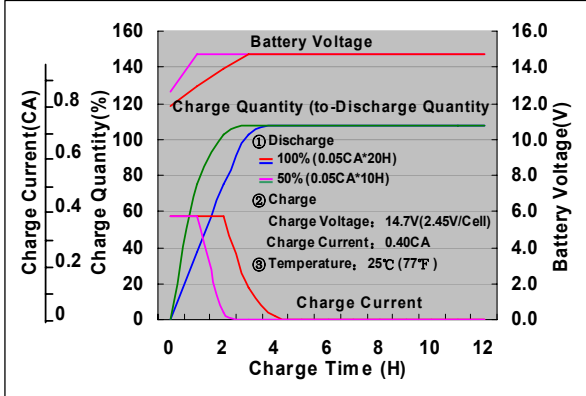

**Discharge capacity by temperature and by discharge current**

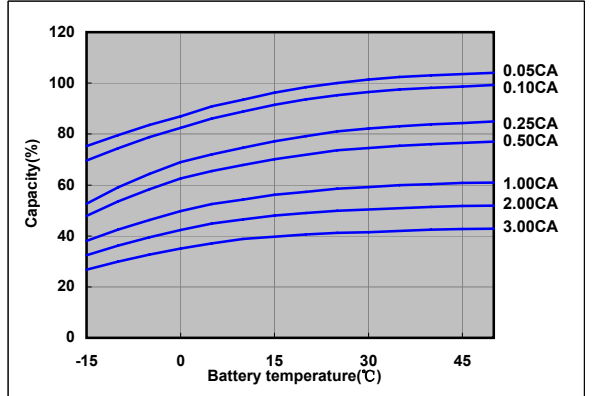

**Discharge characteristics(25°C)**

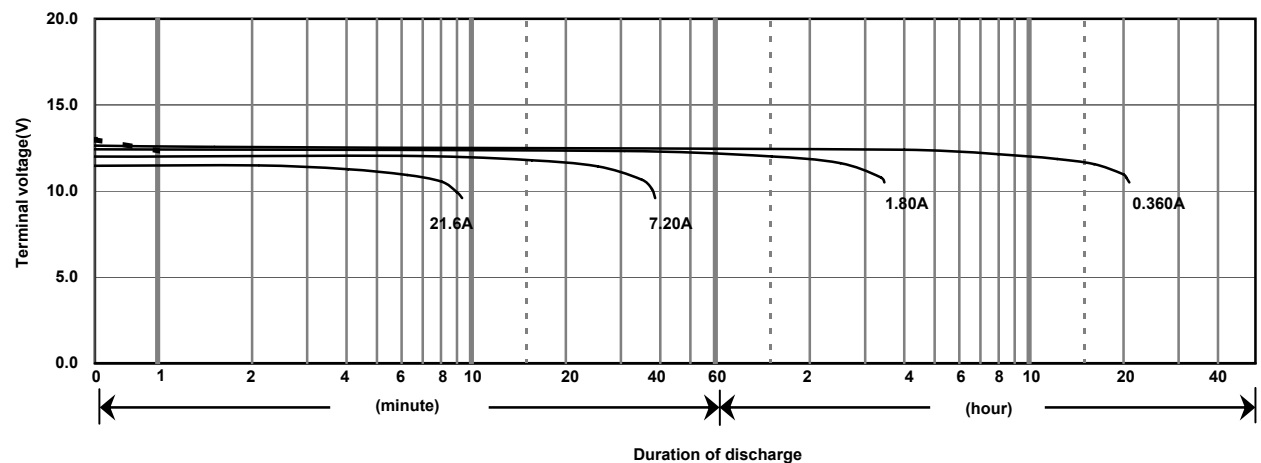

**Caution**  
 Due to the potential energy stored in the batteries, Please read 《Precautions for handling the Rechargeable Valve Regulated Lead Acid Batteries》 before using batteries. If improper handling or use of the batteries without understanding 《Precautions for handling the Rechargeable Valve Regulated Lead Acid Batteries》 may result in bodily injury caused by electrolyte leakage, heat generation, or explosion.

**Panasonic Storage Battery**

2016.08