

THIS DOCUMENT IS SUBJECT TO CHANGE WITHOUT NOTICE. IT IS CONFIDENTIAL AND A PROPERTY OF Amphenol LTW. DISCLOSURE TO THIRD PARTY HAS TO BE AUTHORIZED BY Amphenol LTW.

REV.	ECN NO.	DATE	SIGN	DESCRIPTION
H	C221973	2022/12/26	Ruru	△ XI
I	C230126	2023/02/01	Arvin Chan	△ XI
J	C231052	2023/08/11	Jack Liu	△ XI

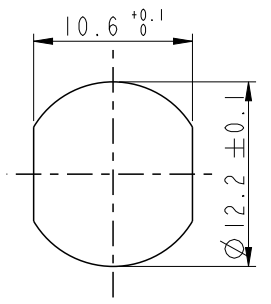

Recommended Panel Cut-Out

MSAS-XXPFFR-SF7003
XX: No. Of Pin

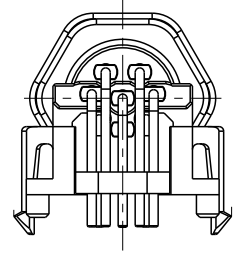
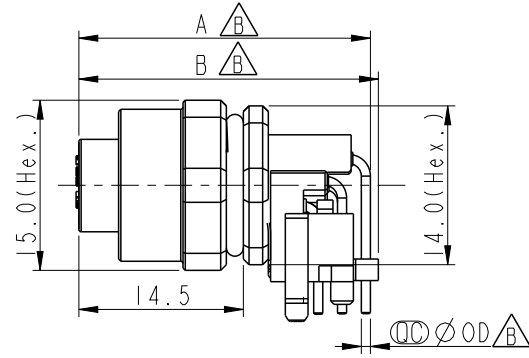
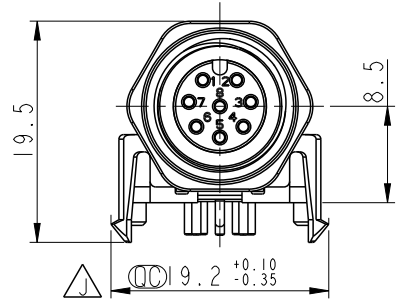
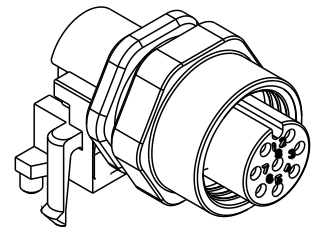
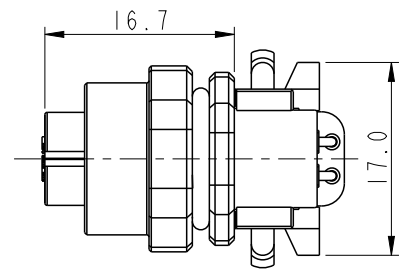

MSAS-03PFFR-SF7003	26.6	25.5	1.0
MSAS-04PFFR-SF7003	26.6	25.5	1.0
MSAS-05PFFR-SF7003	26.6	25.5	1.0
MSAS-08PFFR-SF7003	26.4	25.7	0.8
Item No.	A	B	OD

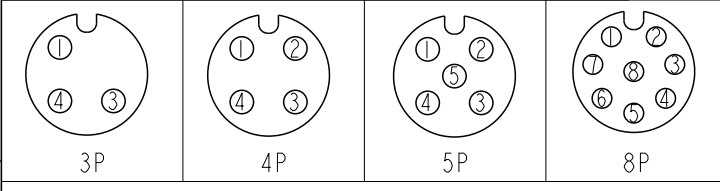

Pin Assignment Front View

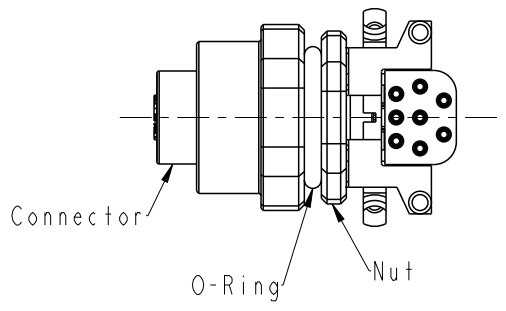

- △ Note:
- * RoHS Compliant
 - * ∅ Important dimension
 - △ * Waterproof rate: IP67, mated Connector
 - Housing: Thermoplastic, Black
 - Pin: Copper alloy, Gold plated
 - △ O-Ring1: Rubber, Gray
 - O-Ring2: Rubber, Gray
 - Nut: Metal
 - * Nut: Metal
 - * O-Ring: Rubber, Gray
 - * For panel thickness max: 3.0mm
 - * For pcb thickness max: 1.6mm
 - △ * Connector nut is packed separately in pe bag

UNIT: mm			TITLE N SEN, M12 A -SHLD, SCREW RECEPTACLE, F, F, PCB R △
TOLERANCE .X ±0.25 .XX ±0.1 .XXX ±0.05 ANGLES ±1°	SCALE 3:2	SIZE A4	SHEET 1 OF 2
REV. J	WC-REV. A.3	∅ Inspection item	

Amphenol LTW
安費諾亮泰企業股份有限公司

ITEM NO.	DRAWN BY Su Nan	DATE 2019-03-21
DWG NO. MSAS-XXPFFR-SF7003	CHECKED BY Feng	DATE 2019-03-21
CUSTOMER ALTW	APPROVED BY Jerry	DATE 2019-03-21

THIS DOCUMENT IS SUBJECT TO CHANGE WITHOUT NOTICE. IT IS CONFIDENTIAL AND A PROPERTY OF Amphenol LTW. DISCLOSURE TO THIRD PARTY HAS TO BE AUTHORIZED BY Amphenol LTW.

PCB Layout

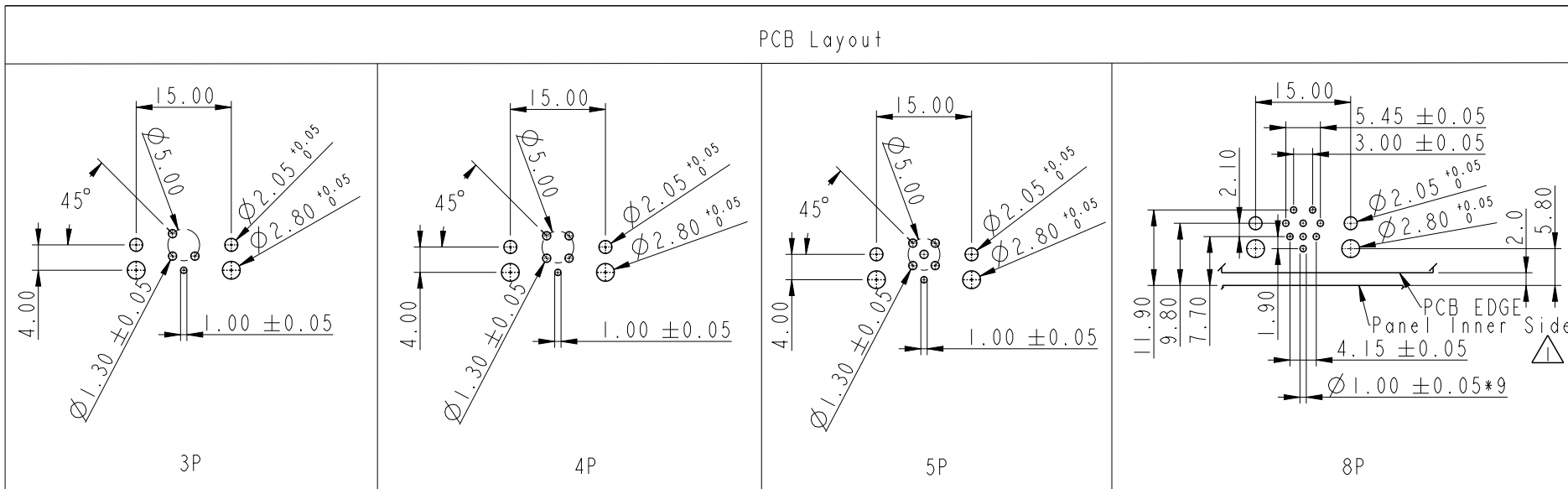

A	UNIT: mm	TITLE N SEN, M12 A -SHLD, SCREW RECEPTACLE, F, F, PCB R	
	TOLERANCE .X ±0.25 .XX ±0.1 .XXX ±0.05 ANGLES ±1°	SCALE 3:2	SIZE A4
		REV. J	WC-REV. A.3
		SHEET 2 OF 2 ①: Inspection item	

Amphenol LTW
安費諾亮泰企業股份有限公司

ITEM NO	DRAWN BY Su Nan	DATE 2019-03-21
DWG NO MSAS-XXPFFR-SF7003	CHECKED BY Feng	DATE 2019-03-21
CUSTOMER ALTW	APPROVED BY Jerry	DATE 2019-03-21