



# MPPT Solar Charge Controller

---

## User Manual



Tracer1206AN G3/ Tracer1210AN G3

Tracer2206AN G3/ Tracer2210AN G3

Tracer3210AN G3/ Tracer4210AN G3



# Important Safety Instructions

## Please reserve this manual for future review.

This manual contains safety, installation, and operation instructions for the Tracer-AN G3 series MPPT solar controller ("controller" referred to in this manual).

- Read all the instructions and warnings carefully in the manual before installation.
- No user-serviceable components inside the controller; please do not disassemble or attempt to repair the controller.
- Mount the controller indoors. Avoid exposure to the components and do not allow water to enter the controller.
- Install the controller in a well-ventilated place; the controller's heat sink may become hot during operation.
- We suggest installing appropriate external fast-acting fuses/breakers.
- Disconnect PV array connections and the battery fast-acting fuse/breakers before controller installation and adjustment.
- Power connections must remain tight to avoid excessive heating from a loose connection.



**WARNING**

Do not install the controller in humid, high salt spray, corrosion, greasy, flammable, explosive, dust accumulative, or other severe environments.

# Disclaimers

## The warranty does not apply to the following conditions:

- Damage caused by improper use or inappropriate environment (such as the humid, high salt spray, corrosion, greasy, flammable, explosive, dust accumulative, or other severe environments).
- The actual current/voltage/power exceeds the limit value of the controller.
- Damage caused by working temperature exceeding the rated range.
- Arc, fire, explosion, and other accidents caused by failure to follow the controller stickers or manual instructions.
- Unauthorized dismantling or attempted repair.
- Damage caused by force majeure.
- Damage occurred during transportation or handling.

# Contents

<b>1 General Information</b>	<b>1</b>
1.1 Overview	1
1.2 Characteristics	3
1.3 Naming rules	4
1.4 Connection diagram	4
1.5 Maximum Power Point Tracking Technology	5
1.6 Battery charging stage	7
<b>2 Installation</b>	<b>10</b>
2.1 Attentions	10
2.2 Requirements for the PV array	10
2.3 Wire size	11
2.4 Mounting	13
<b>3 LCD</b>	<b>16</b>
3.1 Buttons	16
3.2 Interface	16
3.3 Setting	18
3.3.1 Clear the generated energy	18
3.3.2 Switch the battery temperature unit	18
3.3.3 Battery type	18
3.3.4 Load modes	25
<b>4 Others</b>	<b>27</b>
4.1 Protection	27
4.2 Troubleshooting	28
4.3 Maintenance	30
<b>5 Specifications</b>	<b>31</b>
<b>Annex I Conversion Efficiency Curves</b>	<b>33</b>

# 1 General Information

## 1.1 Overview

Tracer-AN G3 series controllers, based on a new design concept, adopt the solar charge controller as the main component. With optional 4G or Wi-Fi modules, the end-users read and write parameters by phone APP conveniently.

Adopting the advanced MPPT control algorithm, the Tracer-AN solar controller can minimize the maximum power point loss rate and time. It makes this product tracks the PV array's maximum power point and obtains maximum energy under any situation. Compared with the PWM charging method, MPPT solar controllers can increase the energy utilization ratio by 10%-30%. Charging current limit, charging power limit, and high temperature charging automatic power reduction fully ensure system stability when access to excess PV modules and high temperature running. Add a professional protection chip for the RS485 port, which further improves the reliability and meets the different application requirements.

The Tracer-AN series controller owns a self-adaptive three-stage charging mode based on a digital control circuit. It can effectively prolong the battery lifespan and significantly improve the system's performance. They are equipped with comprehensive electronic protections to ensure the solar system is more reliable and durable. This controller can be widely used for RV, household systems, field monitoring, and many other applications.

### Features:

- High quality and low failure rate components of ST or IR to ensure the service life
- Advanced MPPT technology, with Max. tracking efficiency higher than 99.5%.
- Advanced MPPT control algorithm to minimize the lost rate and lost time
- Accurate recognizing and tracking technology of multi-peaks maximum power point
- Wider MPP(maximum power point) running voltage to optimize PV utilization
- Maximum DC/DC conversion efficiency of 98%
- Support multi battery types including lithium batteries
- Equipped with a stable self-activation function for the lithium battery
- Set the battery voltage parameters on the LCD<sup>①</sup>
- Battery temperature compensation
- Limit the charging power & charging current to no higher than the rated value

- Real-time energy statistics function
  - Charging power reduction automatically for over-temperature
  - RS485 communication interface with optional 4G or Wi-Fi modules for remote monitoring
  - Standard Modbus communication protocol based on the RS485 communication bus, extending the communication distance
  - A power protection chip, which can provide 5VDC/200mA power and over-current, short-circuit protections, is adopted by the communication interface
  - Setting parameters via the PC software, APP, or remote meter
  - Constant voltage output function<sup>②</sup>
  - Comprehensive electronic protections
  - Multiple load work modes
  - Low self-consumption, lower than 10mA
  - Operation at full load without charging power reduced in the working temperature range
- ① For the Boost Charging Voltage (BCV), Float Charging Voltage (FCV), Low Voltage Disconnect Voltage (LVD), and Low Voltage Reconnect Voltage (LVR), users can modify them on the controller LCD when the battery type is "USE."
- ② To enable the constant voltage output function, ensure the input power is higher than the output power. Suppose the input power is lower than the output power. In that case, the controller enters the ON-OFF state intermittently caused by the under-voltage protection.

## 1.2 Characteristics

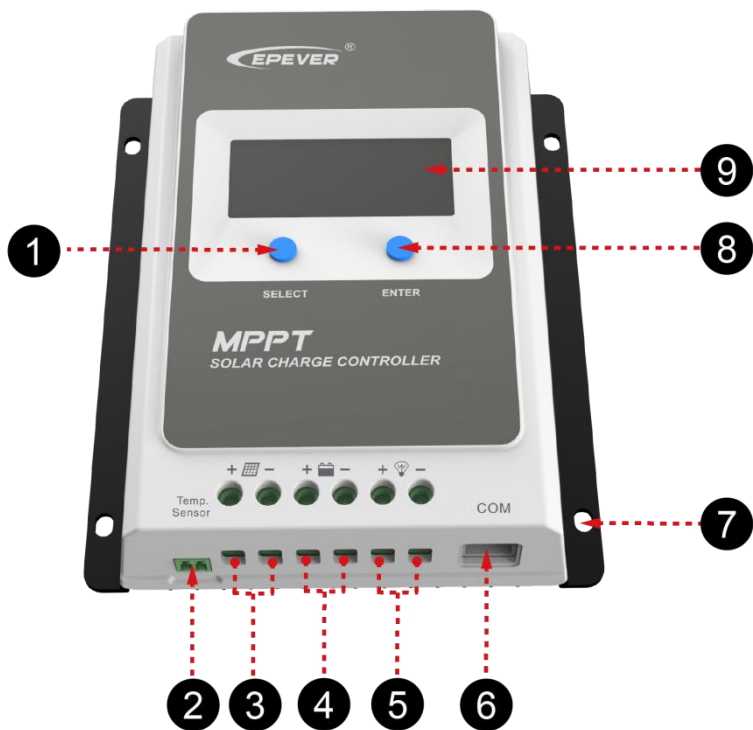

Figure 1-1 Product Characteristics

1	SELECT button	6	RS485 port (no isolation)
2	RTS interface	7	Mounting Hole $\Phi$ 5mm
3	PV Terminals	8	ENTER button
4	Battery terminals	9	LCD
5	Load terminals		

★ Suppose the remote temperature sensor is not connected to the controller or damaged. In that case, the controller will charge or discharge the battery at the default temperature setting of 25 °C (no temperature compensation).



## 1.3 Naming rules

### Tracer 4 2 10 AN G3

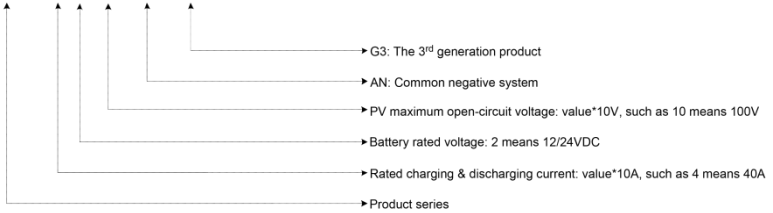

## 1.4 Connection diagram

- **No-battery Mode**

<p><b>WARNING</b></p>	<p>When there is no battery, the Tracer-AN G3 series can be directly connected to the inverter. The inverter shall be connected to the battery terminals of the controller and meets the following conditions:</p> <ol style="list-style-type: none"><li>1) For high-frequency inverter: <math>PV \text{ input power} &gt; (\text{load output power} \div \text{inverter conversion efficiency} \div \text{controller conversion efficiency})</math></li><li>2) For power frequency inverter: <math>PV \text{ input power} &gt; (\text{load output power} \div \text{inverter conversion efficiency} \div \text{controller conversion efficiency} \div 2)</math></li></ol>
-----------------------	--

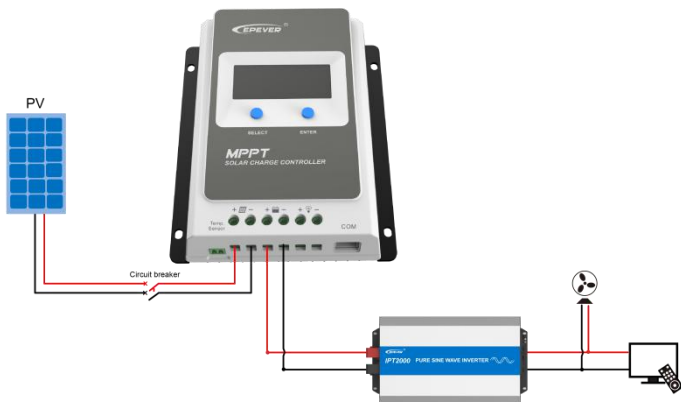

- **Battery Mode**

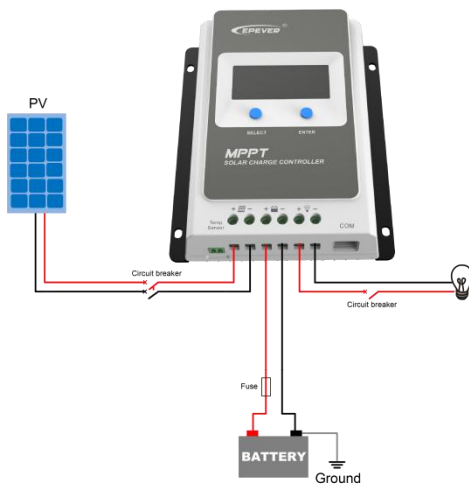

**CAUTION**

- The cable length of the battery should not exceed 3 meters.
- The recommended cable length of the PV array should not exceed 3 meters (Note: If the cable length of the PV array is less than 3 meters, the system meets EN/IEC61000-6-3 requirements. If more than 3 meters, the system may not meet EN/IEC61000-6-3 requirements).

## 1.5 Maximum Power Point Tracking Technology

Due to the nonlinear characteristics of the solar array, there is a maximum energy output point (Max Power Point) on its curve. Traditional controllers, equipped with switch charging technology and PWM charging technology, can't charge the battery at the maximum power point and cannot obtain the maximum energy available from the PV array. In contrast, the solar charge controller with Maximum Power Point Tracking (MPPT) Technology can lock the point to obtain the maximum energy and deliver it to the battery.

Our company's MPPT algorithm continuously compares and adjusts the operating points to locate the array's maximum power point. The tracking process is fully automatic and does not need the user's adjustment.

As Figure 1-2, the curve is also the array's characteristic curve; the MPPT technology will 'boost' the battery charge current by tracking the MPP. Assuming 100% conversion efficiency exists in the solar system, the following formula is established:

$$\text{Input power (P}_{PV}\text{)} = \text{Output power (P}_{Bat}\text{)}$$



$$\text{Input voltage (V}_{Mpp}\text{)} * \text{input current (I}_{PV}\text{)} = \text{Battery voltage (V}_{Bat}\text{)} * \text{battery current (I}_{Bat}\text{)}$$

Normally, the  $V_{Mpp}$  is always higher than  $V_{Bat}$ . Due to the principle of energy conservation, the  $I_{Bat}$  is always higher than  $I_{PV}$ . The greater the difference between  $V_{Mpp}$  &  $V_{Bat}$ , the greater the difference between  $I_{PV}$  &  $I_{Bat}$ . The greater the difference between the array and the battery will also decrease the system conversion efficiency. Therefore, the controller's conversion efficiency is particularly important in the PV system.

Figure 1-2 is the maximum power point curve, whose shaded area is the traditional solar charge controller (PWM Charging Mode). It is known that the MPPT mode can improve solar PV usage. According to the test, the MPPT controller can raise 20%-30% efficiency compared to the PWM controller. (Specified value may fluctuate due to the circumstance's influence and energy loss.)

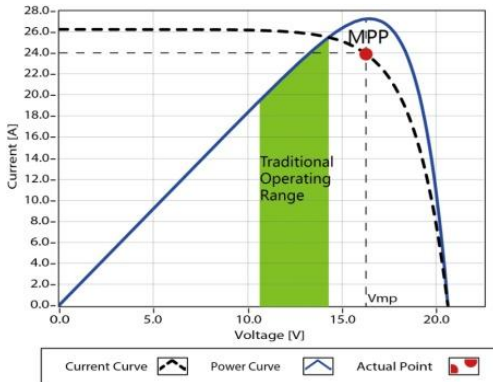

Figure 1-2 Maximum Power Point Tracking Technology

In actual application, the panel may appear Multi-MPP as shading from cloud, tree, and snow. However, in actuality, there is only one real Maximum Power Point. As the Figure 1-3 show:

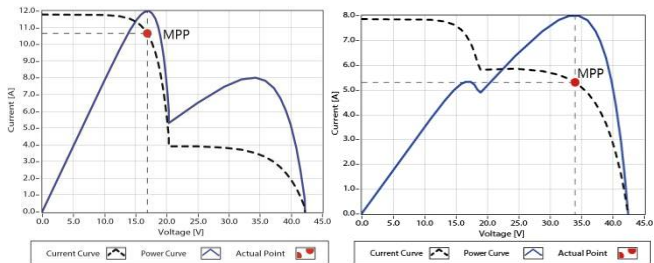

Figure 1-3 Mutil-MPP Curve

Suppose the program works improperly after appearing Multi-MPP. In that case, the system will not work on the real max power point, which may waste most solar energy resources and seriously affect the system's normal operation. The typical MPPT algorithm, designed by our company, can track the real MPP quickly and accurately. It can improve the PV array's utilization rate and avoid resource waste.

## 1.6 Battery charging stage

The controller has a three-stage battery charging algorithm, including Bulk Charging, Constant Charging, and Float Charging. The system can extend the battery's lifespan through the three-stage charging method.

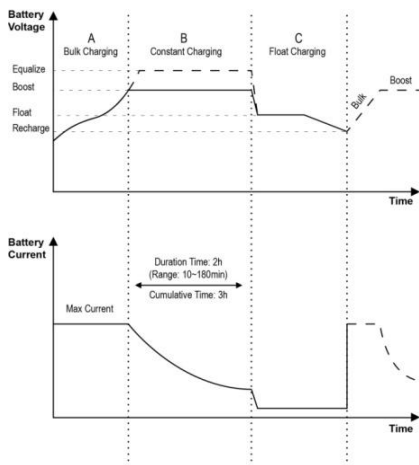

Figure 1-4 Battery charging stage curve

## A) Bulk Charging

The battery voltage has not yet reached constant voltage (Equalize or Boost Charging Voltage). The controller operates in constant current mode, delivering its maximum current to the batteries (MPPT Charging). When the battery voltage reaches the constant voltage set point, the controller will start to operate in constant charging mode.



## B) Constant Charging

When the battery voltage reaches the constant voltage set point, the controller will start to operate in constant charging mode. The MPPT charging stops during this process, and the charging current will drop gradually simultaneously. Constant charging has two stages, namely, equalize charging and boost charging. These two charging processes are not repeated. Among them, equalized charging starts on the 28th of each month.

### > Boost Charging

The default duration of the boost charging stage is generally 2 hours. Customers can adjust the constant time and preset value according to actual needs. The system will switch to the float charging stage when the duration is equal to the set value.

### > Equalize Charging

 <b>WARNING</b>	Explosive Risk! Equalizing flooded batteries would produce explosive gases, so well ventilation of the battery box is recommended.
 <b>CAUTION</b>	<ul style="list-style-type: none"><li>• Equipment damage!</li><li>• Equalization may increase battery voltage to the level that damages sensitive DC loads. Verify that the load's allowable input voltages are greater than the equalize charging voltage.</li><li>• Over-charging and excessive gas precipitation may damage the battery plates and activate material shedding on them. Too high an equalized charging or for too long may cause damage. Please carefully review the specific requirements of the battery used in the system.</li></ul>

Some battery types benefit from equalizing charging, stirring electrolytes, balancing battery voltage, and accomplishing chemical reactions. Equalize charging increases the battery voltage to make it higher than the standard complement voltage, gasifying the battery electrolyte.

If the controller automatically controls the next charge for equalizing charging, the equalizing charging time is 120 minutes. Equalize and boost charges are not carried out constantly in a full charge process to avoid too much gas precipitation or overheating of the battery.

 <b>CAUTION:</b>	<ul style="list-style-type: none"><li>• Due to the installation environment or load work, the system may not stabilize the battery voltage at a constant voltage. The controller will accumulate the time</li></ul>
--	---

	<p>when the battery voltage is equal to the set value. When the accumulative time is equal to 3 hours, the system will automatically switch to float charging.</p> <ul style="list-style-type: none"><li>• If the controller time is not adjusted, the controller will equalize charging following the inner time.</li></ul>
--	--

### **C) Float Charging**

After the constant charging stage, the controller will reduce the battery voltage to the float charging preset voltage by reducing the charging current. During the floating charge stage, the battery is charged weakly to ensure that the battery is maintained in a fully charged state. In the float charging stage, loads can obtain almost all power from the solar panel. Suppose loads' power exceeds the solar array's power. In that case, the controller will no longer maintain the battery voltage in the float charging stage. When the battery voltage goes lower than the boost voltage reconnect voltage, the system will exit the float charging stage and enter the bulk charging stage again.

## 2 Installation

### 2.1 Attentions

- Please read the instructions to familiarize yourself with the installation steps before installation.
- Do not install the controller in humid, high salt spray, corrosion, greasy, flammable, explosive, dust accumulative, or other severe environments.
- Be careful when installing the batteries. Please wear eye protection when installing the open-type lead-acid battery and rinse with clean water in time for battery acid contact.
- Keep the battery away from any metal objects, which may cause a short circuit of the battery.
- Acid gas may be generated when the battery is charged. Confirm that the surrounding environment is well ventilated.
- Avoid direct sunlight and rain infiltration when installing it outdoor.
- Loose power connectors and corroded wires may produce high heat that can melt wire insulation, burn surrounding materials, or even cause a fire. Ensure tight connections and secure cables with cable clamps to prevent them from swaying in moving applications.
- Only charge the lead-acid and lithium-ion batteries within the control range of this controller.
- The battery connector may be wired to another battery or a bank of batteries. The following instructions refer to a singular battery. Still, it is implied that the battery connection can be made to either one battery or a group of batteries in a battery bank.
- Select the system cables according to 5A/mm<sup>2</sup> or less current density.
- The wire size of the grounding wire should not be less than 4mm<sup>2</sup>.
- The torque of tightening the wiring screw should not be less than 1.2N.m.

### 2.2 Requirements for the PV array

#### Serial connection (string) of PV modules

As the core component of the solar system, the controller needs to suit various types of PV modules and maximize solar energy conversion into electricity. According to the open-circuit voltage ( $V_{OC}$ ) and the maximum power point voltage ( $V_{MPP}$ ) of the MPPT controller, the serial connection of PV modules suitable for different controllers can be calculated. The below table is for reference only.

#### Tracer1206/2206AN G3:

System voltage	36cell		48cell		54cell Voc < 34V		60cell Voc < 38V	
	Voc < 23V		Voc < 31V					
	Max.	Best	Max.	Best	Max.	Best	Max.	Best
12V	2	2	1	1	1	1	1	1

24V	2	2	-	-	-	-	-	-
-----	---	---	---	---	---	---	---	---

System voltage	72cell Voc < 46V		96cell Voc < 62V		Thin-Film module Voc > 80V
	Max.	Best	Max.	Best	
12V	1	1	-	-	-
24V	1	1	-	-	-



**CAUTION**

The above parameters are calculated under the STC (Standard Test Condition)—module temperature 25°C, air mass 1.5, irradiance 1000W/m<sup>2</sup>.)

**Tracer1210/2210/3210/4210AN G3:**

System voltage	36cell Voc < 23V		48cell Voc < 31V		54cell Voc < 34V		60cell Voc < 38V	
	Max.	Best	Max.	Best	Max.	Best	Max.	Best
12V	4	2	2	1	2	1	2	1
24V	4	3	2	2	2	2	2	2

System voltage	72cell Voc < 46V		96cell Voc < 62V		Thin-Film module Voc > 80V
	Max.	Best	Max.	Best	
12V	2	1	1	1	1
24V	2	1	1	1	1



**CAUTION**

The above parameters are calculated under the STC (Standard Test Condition)—module temperature 25°C, air mass 1.5, irradiance 1000W/m<sup>2</sup>.)

## 2.3 Wire size

The wiring and installation methods conform to the national and local electrical code requirements.

➤ **PV wire size**

The PV array's output current varies with size, connection method, and sunlight angle. Its ISC (short circuit current) can calculate the minimum wire size. Please refer to the ISC value in the PV module's specifications. When the PV modules are connected in series, the total ISC equals any PV module's ISC.

When the PV modules are connected in parallel, the total ISC equals the sum of the PV module's ISC.



The PV array's ISC must not exceed the controller's maximum PV input current. For max. PV input current and max. PV wire size, please refer to the table below:

Model	Max. PV input current	Max. PV wire size*	Circuit breaker
Tracer1206/1210AN G3	10A	4mm <sup>2</sup> /12AWG	16A/125V/2P
Tracer2206/2210AN G3	20A	6mm <sup>2</sup> /10AWG	32A/125V/2P
Tracer3210AN G3	30A	10mm <sup>2</sup> /8AWG	40A/125V/2P
Tracer4210AN G3	40A	16mm <sup>2</sup> /6AWG	63A/125V/2P



**CAUTION**

The total voltage must not exceed the PV maximum open-circuit voltage when the PV modules are connected in series. The PV maximum open-circuit voltage is 46V(Tracer\*\*06AN G3) or 92V(Tracer\*\*10AN G3) at 25°C environment temperature.

➤ **Battery and Load Wire Size**

The battery and load wire size conform to the rated current, and the reference size as below:



Model	Rated charge current	Rated discharge current	Battery wire size	Load wire size	Circuit breaker
Tracer1206/1210AN G3	10A	10A	4mm <sup>2</sup> /12AWG	4mm <sup>2</sup> /12AWG	16A/125V/2P
Tracer2206/2210AN G3	20A	20A	6mm <sup>2</sup> /10AWG	6mm <sup>2</sup> /10AWG	32A/125V/2P
Tracer3210AN G3	30A	30A	10mm <sup>2</sup> /8AWG	10mm <sup>2</sup> /8AWG	40A/125V/2P
Tracer4210AN G3	40A	40A	16mm <sup>2</sup> /6AWG	16mm <sup>2</sup> /6AWG	63A/125V/2P



**CAUTION**

- The wire size is only for reference. Suppose there is a long distance between the PV array and the controller or between the controller and the battery. In that case, larger wires can be used to reduce the voltage drop and improve performance.
- The recommended wire is selected for the battery according to the conditions that its terminals are not connected to any additional inverter.

## 2.4 Mounting

 <b>WARNING</b>	<ul style="list-style-type: none"><li>• Risk of explosion! Never install the controller in a sealed enclosure with flooded batteries! Do not install the controller in a confined area where battery gas can accumulate.</li><li>• Risk of electric shock! The PV array may generate a high open-circuit voltage when wiring the PV modules. Disconnect the breaker or fast-acting fuse first, and be careful when wiring.</li></ul>
 <b>CAUTION</b>	The controller requires at least 150mm of clearance above and below for proper airflow. Ventilation is highly recommended if mounted in an enclosure.

Installation procedures:

**Step 1: Determine the installation location and heat-dissipation space**

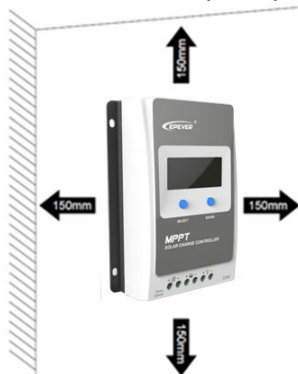





Figure2-1 Mounting

**Step 2: Connect the system in the order of battery  -- load  --PV array  following Figure 2-2," Schematic Wiring Diagram," and disconnect the system in the reverse order.**

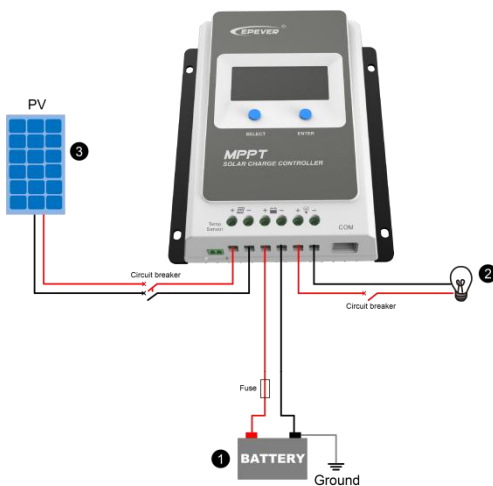

Figure 2-2 Schematic Wiring Diagram



**CAUTION**

- Please do not connect the circuit breaker or fast-acting fuse during the wiring and ensure that the electrode polarity is correctly connected.
- A fast-acting fuse whose current is 1.25 to 2 times the controller's rated current must be installed on the battery side with a distance from the battery no longer than 150 mm.
- The cable length of the battery should not exceed 3 meters.
- The recommended cable length of the PV array should not exceed 3 meters (Note: If the cable length of the PV array is less than 3 meters, the system meets EN/IEC61000-6-3 requirements. If more than 3 meters, the system may not meet EN/IEC61000-6-3 requirements).
- Suppose the controller is to be used in an area with frequent lightning strikes or an unattended area. In that case, it must install an external surge arrester.
- If an inverter is to be connected to the system, connect the inverter directly to the battery, not to the load side of the controller.

**Step 3: Grounding**

Tracer-AN G3 series are common-negative controllers. Negative terminals of the PV array, the battery, and the load can be grounded simultaneously, or any negative terminal is grounded. However, according to the practical application, the negative terminals of the PV array, battery, and load can also be

ungrounded. However, the grounding terminal on its shell must be grounded. It shields electromagnetic interference and avoids electric shock to the human body.

	<p><b>CAUTION</b></p> <p>It is recommended to use a common-negative controller for common-negative systems, such as the RV system. The controller may be damaged if a common-positive controller is used and the positive electrode is grounded in the common-negative system.</p>
--	--

#### Step 4: Connect accessories

- **Connect the temperature sensor**



**Included Accessory:**

(Model: RT-MF58R47K3.81A)



**Optional Accessory:**

(Model: RTS300R47K3.81A)

Connect one end of the remote temperature sensor cable to the interface ③ and place the other end close to the battery.

	<p><b>CAUTION</b></p> <p>Suppose the remote temperature sensor is not connected to the controller or is damaged. In that case, the controller will charge or discharge the battery at the default 25 °C (no temperature compensation).</p>
--	--

- **Connect the accessories for RS485 communication**

Refer to 3.3 "Setting."

	<p><b>CAUTION</b></p> <p>The internal circuit of the RS485 port has no isolation design. Connecting an RS485 communication isolator to the port is recommended before communicating.</p>
--	--

#### Step 5: Power on the controller

Connect the battery fast-acting fuse to power the controller. Check the battery indicator status (the controller operates normally when the indicator is lit green). Connect the fast-acting fuse and circuit breaker of the load and PV array. Then the system will be operating in preprogrammed mode.

	<p><b>CAUTION</b></p> <p>If the controller is not operating properly or the battery indicator shows an abnormality, please refer to 4.2 "Troubleshooting."</p>
--	--

## 3 LCD

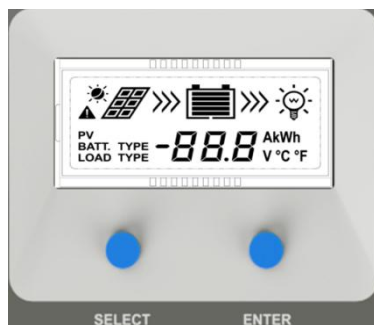

**Note:** The display screen can be viewed clearly when the angle between the end-users horizontal sight and the display screen is within 90°. If the angle exceeds 90°, the information on the display screen cannot be viewed clearly.





### 3.1 Buttons

Mode	Note
Load ON/OFF	It can turn the load On/Off via the <b>ENTER</b> button in manual load mode.
Clear fault	Press the <b>ENTER</b> button.
Browsing mode	Press the <b>SELECT</b> button.
Setting mode	Press the <b>ENTER</b> button and hold on 5s to enter the setting mode. Press the <b>SELECT</b> button to set the parameters. Press the <b>ENTER</b> button to confirm the setting parameters or no operation for 10s. It will exit the setting interface automatically.





### 3.2 Interface

#### 1) Status Description

Name	Icon	Status
PV array		Day
		Night
		No charge

		Charging
	<b>PV</b>	PV array's voltage, current, and generate energy
Battery		Battery capacity, In charging
	<b>BATT.</b>	Battery Voltage, Current, Temperature
	<b>BATT. TYPE</b>	Battery type
Load		Load ON
		Load OFF
	<b>LOAD</b>	Current/Consumed energy/Load mode

## 2) Error codes

Status	Icon	Instruction
Battery over-discharged		Battery level shows empty, battery frame blink, fault icon blink
Battery over voltage		Battery level shows full, battery frame blink, fault icon blink
Battery overheating		Battery level shows current value, battery frame blink, fault icon blink
Load failure		Overload <sup>①</sup> , Load short circuit

① When the load current reaches 1.02-1.05 times, 1.05-1.25 times, 1.25-1.35 times, and 1.35-1.5 times more than the rated value, the controller will automatically turn off the loads in 50 seconds, 30 seconds, 10 seconds, and 2 seconds respectively.

## 3) Browse interface

Press the **SELECT** button to cycle display the following interfaces.

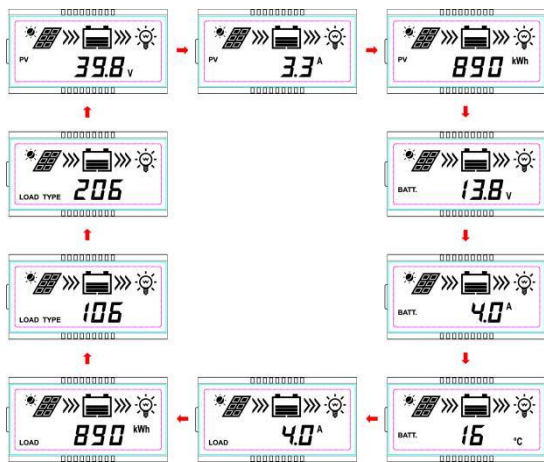

## 3.3 Setting

### 3.3.1 Clear the generated energy

**Step 1:** Press the **ENTER** button and hold 5s under the PV-generated energy interface, and the value will flash.

**Step 2:** Press the **ENTER** button to clear the generated energy.

### 3.3.2 Switch the battery temperature unit

Press the button and hold for 5s under the battery temperature interface to switch the temperature unit.

### 3.3.3 Battery type

#### 1. Supported battery types

1	Battery	Sealed(default)
		Gel
		Flooded
2	Lithium battery	LiFePO4 (4S/12V; 8S/24V)
		Li(NiCoMn)O2 (3S/12V; 6S/24V; 7S/24V)
3	User	

#### 2. Local set the battery type

**Operation:**

**Step1:** Press the **SELECT** button to jump to the battery voltage interface.

**Step2:** Press and hold the **ENTER** button until the battery-type interface flashes.

**Step3:** Press the **SELECT** button to change the battery type, shown below:

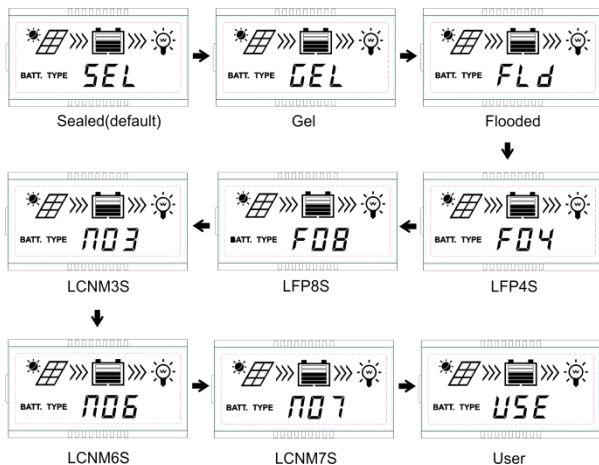

**Step4:** Press the **ENTER** button to confirm.

### 3. Remote set the battery parameters

#### 1) Setting the battery parameters by PC software

Connect the controller's RJ45 port to the PC's USB interface via a USB to RS485 cable. When selecting the battery type as "USE," set the voltage parameters by the PC software.

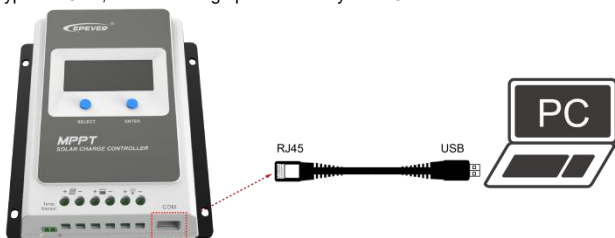



## 2) Setting the battery parameters by APP

- **Via an external WiFi 2.4G adapter**

Connect the controller to an external WiFi 2.4G adapter by the RS485 communication port. End-users can set the voltage parameters by the APP after selecting the battery type as "USE." Refer to the cloud APP manual for details.



- **Via an external Bluetooth adapter**

Connect the controller to an external Bluetooth adapter by the RS485 communication port. End-users can set the voltage parameters by the APP after selecting the battery type as "USE." Refer to the cloud APP manual for details.



## 3) Setting the battery parameters by MT52

Connect the controller to the remote meter (MT52) through a standard network cable. After selecting the battery type as "USE," set the voltage parameters by the MT52. Refer to the MT52 manual or after-sales engineer for details.

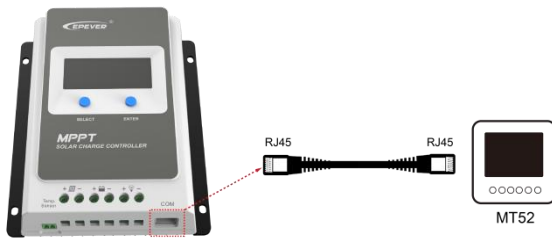

#### 4. Local set the battery parameters

##### Operation:

**Step1:** Press and hold the ENTER button to enter the battery type interface on the battery voltage interface.

**Step2:** Press the SELECT button to change the battery type, such as selecting the "GEL," and then press the ENTER button to confirm and go back to the battery voltage interface automatically.

**Step3:** On the battery voltage interface, press and hold the ENTER button to enter the battery type interface again.

**Step4:** Press the SELECT button to change the battery type to the "USE." Under the "USE" battery type, the battery parameters can be set via the LCD.

Parameters	Default	Range	Operation Steps
System voltage level (SYS)★	12VDC	12/24 VDC	1) Under the "USE" interface, press the ENTER button to enter the "SYS" interface. 2) Press the ENTER button again to display the current "SYS" value. 3) Press the SELECT button to modify the parameter. 4) Press the ENTER button to confirm and enter the next parameter.  5) Press the ENTER button again to display the current-voltage value. 6) Press the SELECT button to modify the parameter (short press to increase 0.1V, long press to decrease 0.1V). 7) Press the ENTER button to confirm and enter the next parameter.
Boost charging voltage (BCV)	14.4V	9~17V	
Float charging voltage (FCV)	13.8V	9~17V	
Low voltage reconnect voltage (LVR)	12.6V	9~17V	
Low voltage disconnect voltage (LVD)	11.1V	9~17V	

Lithium battery protection enable (LEN)	NO	YES/NO	Press the <b>SELECT</b> button to modify the switch status. <b>Note: It exists automatically from the current interface after no operation of more than 10S.</b>
---	----	--------	---

★The SYS value can only be modified under the non-lithium "USE" type. If the battery type is Sealed, Gel, Flooded before entering the "USE" type, the SYS value can be modified. The SYS value cannot be modified if it is a lithium battery type before entering the "USE" type.

Only the above battery parameters can be set on the local controller. The remaining battery parameters follow the following logic (the voltage level of the 12V system is 1, and the voltage level of the 24V system is 2).

Battery type Battery parameters	Sealed/Gel/Flooded User	LiFePO4 User	Li(NiCoMn)O2 User
Over voltage disconnect voltage	BCV+1.4V*voltage level	BCV+0.3V*voltage level	BCV+0.3V*voltage level
Charging limit voltage	BCV+0.6V*voltage level	BCV+0.1V*voltage level	BCV+0.1V*voltage level
Over voltage reconnect voltage	BCV+0.6V*voltage level	BCV+0.1V*voltage level	Boost charging voltage
Equalize charging voltage	BCV+0.2V*voltage level	Boost charging voltage	Boost charging voltage
Boost reconnect charging voltage	FCV-0.6V*voltage level	FCV-0.6V*voltage level	FCV-0.1V*voltage level
Under voltage warning reconnect voltage	UVW+0.2V*voltage level	UVW+0.2V*voltage level	UVW+1.7V*voltage level
Under voltage warning voltage	LVD+0.9V*voltage level	LVD+0.9V*voltage level	LVD+1.2V*voltage level
Discharging limit voltage	LVD-0.5V*voltage level	LVD-0.1V*voltage level	LVD-0.1V*voltage level

## 5. Battery voltage parameters

- Measure the parameters in the condition of 12V/25°C. Please double the values in the 24V system.

Battery parameters	Battery type			
	Sealed	GEL	FLD	User
Over voltage disconnect voltage	16.0V	16.0V	16.0V	9~17V
Charging limit voltage	15.0V	15.0V	15.0V	9~15.5V
Over voltage reconnect voltage	15.0V	15.0V	15.0V	9~15.5V
Equalize charging voltage	14.6V	--	14.8V	9~15.5V
Boost charging voltage	14.4V	14.2V	14.6V	9~15.5V
Float charging voltage	13.8V	13.8V	13.8V	9~15.5V
Boost reconnect charging voltage	13.2V	13.2V	13.2V	9~15.5V
Low voltage reconnect voltage	12.6V	12.6V	12.6V	9~15.5V
Under voltage warning reconnect voltage	12.2V	12.2V	12.2V	9~15.5V
Under voltage warning voltage	12.0V	12.0V	12.0V	9~15.5V
Low voltage disconnect voltage	11.1V	11.1V	11.1V	9~15.5V
Discharging limit voltage	10.6V	10.6V	10.6V	9~15.5V
Equalize Duration	120 minutes	--	120 minutes	0~180 minutes
Boost Duration	120 minutes	120 minutes	120 minutes	10~180 minutes



### CAUTION

When the default battery type is selected, the battery voltage parameters cannot be modified. To change these parameters, select the "USE" type.

- When the battery type is "USE," the battery voltage parameters follow the following logic:
  - Over Voltage Disconnect Voltage > Charging Limit Voltage ≥ Equalize Charging Voltage ≥ Boost Charging Voltage ≥ Float Charging Voltage > Boost Reconnect Charging Voltage.
  - Over Voltage Disconnect Voltage > Over Voltage Reconnect Voltage
  - Low Voltage Reconnect Voltage > Low Voltage Disconnect Voltage ≥ Discharging Limit Voltage.
  - Under Voltage Warning Reconnect Voltage > Under Voltage Warning Voltage ≥ Discharging Limit Voltage;
  - Boost Reconnect Charging voltage > Low Voltage Reconnect Voltage.

## 6. Lithium Battery voltage parameters

Battery type  Battery parameters	LFP		LNCM			
	LFP4S	LFP8S	LNCM 3S	LNCM 6S	LNCM 7S	User*
Over voltage disconnect voltage	14.8V	29.6 V	12.8 V	25.6 V	29.8 V	9~17V
Charging limit voltage	14.6 V	29.2 V	12.6 V	25.2 V	29.4 V	9~15.5
Over voltage reconnect voltage	14.6 V	29.2 V	12.5 V	25.0 V	29.1 V	9~15.5
Equalize charging voltage	14.5 V	29.0 V	12.5 V	25.0 V	29.1 V	9~15.5
Boost charging voltage	14.5 V	29.0 V	12.5 V	25.0 V	29.1 V	9~15.5
Float charging voltage	13.8 V	27.6 V	12.2 V	24.4 V	28.4 V	9~15.5
Boost reconnect charging voltage	13.2 V	26.4 V	12.1 V	24.2 V	28.2 V	9~15.5
Low voltage reconnect voltage	12.8 V	25.6 V	10.5 V	21.0 V	24.5 V	9~15.5
Under voltage warning reconnect voltage	12.2 V	24.4 V	12.2 V	24.4 V	28.4 V	9~15.5
Under voltage warning voltage	12.0 V	24.0 V	10.5 V	21.0 V	24.5 V	9~15.5
Low voltage disconnect voltage	11.1 V	22.2 V	9.3 V	18.6 V	21.7 V	9~15.5
Discharging limit voltage	11.0 V	22.0 V	9.3 V	18.6 V	21.7 V	9~15.5

★ The battery parameter under the "User" battery type is 9-17V for LFP4S. They should x2 for LFP8S.

- When the battery type is "USE," the Lithium battery voltage parameters follow the following logic:
  - Over Voltage Disconnect Voltage > Over Charging Protection Voltage (Protection Circuit Modules (BMS)) + 0.2V;
  - Over Voltage Disconnect Voltage > Over Voltage Reconnect Voltage = Charging Limit Voltage ≥ Equalize Charging Voltage = Boost Charging Voltage ≥ Float Charging Voltage > Boost Reconnect

Charging Voltage;

- C. Low Voltage Reconnect Voltage > Low Voltage Disconnect Voltage  $\geq$  Discharging Limit Voltage.
- D. Under Voltage Warning Reconnect Voltage > Under Voltage Warning Voltage  $\geq$  Discharging Limit Voltage;
- E. Boost Reconnect Charging voltage > Low Voltage Reconnect Voltage;
- F. Low Voltage Disconnect Voltage  $\geq$  Over Discharging Protection Voltage (BMS)+0.2V



**CAUTION**

The required accuracy of BMS is no higher than 0.2V. We will not assume responsibility for the abnormal when the accuracy of BMS is higher than 0.2 v.

### 3.3.4 Load modes

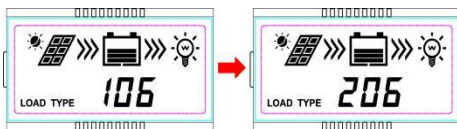

When the LCD shows the above interface, operate as follows:

**Operation:**

**Step1:** Press the **SELECT** button to jump to the load type interface.

**Step2:** Press and hold the **ENTER** button until the load type interface flashes.

**Step3:** Press the **SELECT** button to modify the load type.

**Step4:** Press the **ENTER** button to confirm.

#### 1. Load mode list

1**	Timer 1	2**	Timer 2
100	Light ON/OFF	2 n	Disabled
101	The load will be on for 1 hour since sunset	201	The load will be on for 1 hour before sunrise
102	The load will be on for 2 hours since sunset	202	The load will be on for 2 hours before sunrise
103~113	The load will be on for 3 ~13 hours since sunset	203~213	The load will be on for 3 ~13 hours before sunrise
114	The load will be on for 14 hours since sunset	214	The load will be on for 14 hours before sunrise
115	The load will be on for 15 hours since sunset	215	The load will be on for 15 hours before sunrise
116	Test mode	2 n	Disabled

117	Manual mode(Default load ON)	2 n	Disabled
118	Always ON mode (The load always maintains the output state, and this mode is suitable for loads that require 24-hour power supply)		



**CAUTION**



When selecting the load mode as the Light ON/OFF mode, Test mode, and Manual mode, only the Timer 1 can be set, and the Timer 2 is disabled and display "2 n".

**2. Set load mode**

Set the load modes by PC software, APP, or remote meter (MT52). For detailed connection diagrams and settings, refer to chapter "[3.3.3 Battery type](#) > 3. Remote set the battery parameters."

## 4 Others

### 4.1 Protection

No.	Protections	Instruction
1	PV Over Current	When the actual PV array's charging current or power is higher than the controller's rated charging current or power, the controller will charge the battery per the rated current or power.
2	PV short-circuit protection	Not in the PV charging state, the controller will not be damaged when the PV array is short-circuited.  <b>WARNING:</b> It is forbidden to short-circuit the PV array during charging. Otherwise, the controller may be damaged.
3	PV reverse polarity protection	When the PV array's polarity is reversed, the controller may not be damaged and resume work after correcting the mis-wiring.  <b>CAUTION:</b> If the PV array is reversed and its actual power is 1.5 times the controller's rated power, the controller may be damaged.
4	Night reverse charging protection	Avoid the battery from discharging to the PV module at night.
5	Battery reverse protection	The battery can be reversely connected when the PV is disconnected or reversely connected. Correct the wire connection to resume work.  <b>WARNING:</b> The controller will be damaged when the PV connection is correct and the battery connection is reversed!
6	Battery over voltage protection	When the battery voltage reaches the over voltage disconnect voltage, the PV array will automatically stop charging the battery to avoid battery damage.
7	Battery over-discharging protection	The battery discharging is automatically stopped when the battery voltage is lower than the low voltage disconnect voltage.
8	Battery overheating protection	The controller detects the battery temperature through an external temperature sensor. The battery stops working when its temperature exceeds 65°C and resumes work when it is below 55°C.
9	Lithium battery low temperature protection	When the temperature detected by the optional temperature sensor is lower than the Low-Temperature Protection Threshold(LTPT), the controller will stop charging and discharging automatically. When the detected temperature is higher than the LTPT, the controller will work automatically (The LTPT is 0 °C by default and can be set within 10 ~ -40 °C).











10	Load short circuit protection	When a short circuit occurs on the load side (four times higher than the rated load current), the controller automatically cuts off the output. The output still attempts to resume five times automatically (delay 5 seconds, 10 seconds, 15 seconds, 20 seconds, 25 seconds). Suppose you want the controller to restart the auto-recovery process. In that case, you need to press the Load button, restart the controller, or experience a night-to-day change (night time > 3 hours).
11	Overload protection	If the load current exceeds 1.05 times the controller's rating, the controller will cut off the output after a delay. After the overload occurs, the output attempts to resume automatically five times (delay of 5 seconds, 10 seconds, 15 seconds, 20 seconds, and 25 seconds). Suppose you want the controller to restart the auto-recovery process. In that case, you need to press the Load button, restart the controller, or experience a night-to-day change (night time > 3 hours).
12	Device overheating protection	An internal temperature sensor can detect the internal temperature of the controller. The controller stops working when its internal temperature is higher than 85°C and resumes working when its internal temperature is below 75°C.
13	TVS high voltage transients protection	The controller's internal circuitry is designed with Transient Voltage Suppressors (TVS), which can only protect against high-voltage surge pulses with less energy. Suppose the controller is to be used in an area with frequent lightning strikes. In that case, it is recommended to install an external surge arrester.

★ When the controller's internal temperature reaches 81°C, the charging power automatic reduction function is enabled. Temperature increases by 1 °C, and the charging power is reduced by 5%, 10%, 20%, and 40%. If the internal temperature exceeds 85°C, the controller stops charging the battery. When the internal temperature is lower than or equal to 75°C, the controller resumes charging per the rated charging power.

## 4.2 Troubleshooting

Faults	Faults	Troubleshooting
PV array open-circuit	When there is plenty of direct sunlight on the PV array, the LCD shows 	Confirm whether the connection of the PV array is correct and tight.
The battery voltage is lower than 8V.	The wire connection is correct; the controller is not working.	Please check the battery's voltage (at least 8V voltage to activate the controller).

Battery voltage over	  Battery frame blink,	Check whether the battery voltage is higher than OVD (over voltage disconnect voltage) and disconnect the PV array connection.
Battery discharged	  Battery frame blink,	① When the battery voltage is restored to or above LVR (low voltage reconnect voltage), the load will recover. ② Take other ways to recharge the battery.
Battery overheating	  Battery frame blink,	While the temperature declines below 55 °C, the controller will resume.
Overload	1. Load off	① Please reduce the number of electric devices. ② Restart the controller or press the button to clear faults.
Load short-circuit	2   Load and fault icon blink	① Check carefully loads connection, clear the fault, ② Restart the controller or press the button to clear faults.

① When the load current goes higher than 1.02-1.05 times, 1.05-1.25 times, 1.25-1.35 times, and 1.35-1.5 times the rated value, the controller may automatically turn off loads in 50 seconds, 30 seconds, 10 seconds, and 2 seconds respectively.

## 4.3 Maintenance

The following inspections and maintenance tasks are recommended at least twice yearly for good performance.

- Make sure no block on airflow around the controller. Clear up any dirt and fragments on the radiator.
- Check all the naked wires to ensure insulation is not damaged by sun exposure, frictional wear, dryness, insects or rats, etc. Repair or replace some wires if necessary.
- Verify the indicator display is consistent with the actual operation. Pay attention to any troubleshooting or error conditions. Take necessary corrective action.
- Confirm that terminals have no corrosion, insulation damaged, high temperature, burnt/discolored sign, and tighten terminal screws to the suggested torque.
- Clear up dirt, nesting insects, and corrosion in time.
- Check and confirm that the lightning arrester is in good condition. Replace a new one in time to avoid damaging the controller and other equipment.



**CAUTION**

Risk of electric shock! Ensure that the power is turned off before the above operations, and then follow the corresponding inspections and operations.

## 5 Specifications

Parameter	Tracer1206AN G3	Tracer2206AN G3	Tracer1210AN G3	Tracer2210AN G3	Tracer3210AN G3	Tracer4210AN G3
<b>Electrical Parameters</b>						
Battery Rated Voltage	12/24VDC <sup>①</sup> Auto-recognition					
Rated Charging Current	10A	20A	10A	20A	30A	40A
Rated Discharge Current	10A	20A	10A	20A	30A	40A
Controller Work Voltage Range	8~31V					
PV Maximum Open-circuit Voltage	60V <sup>②</sup> 46V <sup>③</sup>		100V <sup>②</sup> 92V <sup>③</sup>			
MPPT Voltage Range	(Battery voltage +2V)~36V		(Battery voltage +2V)~72V			
Rated Charging Power	130W/12V 260W/24V	260W/12V 520W/24V	130W/12V 260W/24V	260W/12V 520W/24V	390W/12V 780W/24V	520W/12V 1040W/24V
Static Losses	≤8mA(12V) ≤5mA(24V)					
Discharge-circuit Voltage Drop	≤0.23V					
Temperature Compensation <sup>④</sup>	-3mV/°C/2V (Default)					
Grounding Type	Common negative					
RS485 Port	5VDC/200mA(RJ45)					
LCD Backlight Time	Default:60S, Range:0~999S(0 seconds: the backlight is ON all the time)					
<b>Environmental parameters</b>						
Work Temperature Range <sup>⑤</sup>	-25°C~+45°C(100% loads working)					
Storage Temperature Range	-20°C~+70°C					
Relative Humidity	< 95% (N.C.)					
Enclosure	IP30					

① When a lithium battery is used, the system voltage isn't automatically identified.

- ② At minimum operating environment temperature
- ③ At 25°C environment temperature
- ④ When a lithium battery is used, the temperature compensation coefficient will be 0 and can't be changed.
- ⑤ The controller can full load working in the working environment temperature. When the internal temperature reaches 81°C, the reducing charging power mode is turned on. Refer to chapter [4.1 Protection](#).

**Mechanical parameters**

Model	Tracer1206/1210AN G3	Tracer2206/2210AN G3	Tracer3210AN G3	Tracer4210AN G3
Dimension (L x W x H)	172x139x44mm	220x154x52mm	228x164x55mm	252x180x63mm
Mounting Size (L x W)	124x130mm	170x145mm	170x155mm	204x171mm
Mounting Hole Size	Φ5mm			
Terminal	12AWG(4mm <sup>2</sup> )	6AWG(16mm <sup>2</sup> )	6AWG(16mm <sup>2</sup> )	6AWG(16mm <sup>2</sup> )
Recommended Wire Size	12AWG(4mm <sup>2</sup> )	10AWG(6mm <sup>2</sup> )	8AWG(10mm <sup>2</sup> )	6AWG(16mm <sup>2</sup> )
Net Weight	0.57kg	0.94kg	1.26kg	1.65kg

# Annex I Conversion Efficiency Curves

Test condition: Illumination Intensity: 1000W/m<sup>2</sup> Temperature: 25

Model: Tracer1206AN G3

1. PV array Max. power point voltage(17V, 34V)/system voltage(13V)

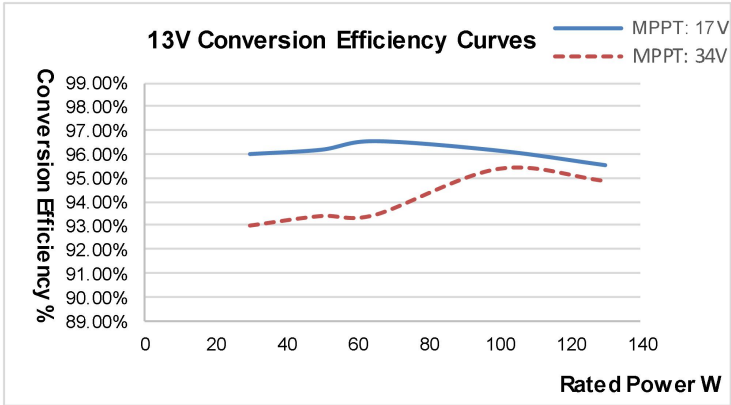

2. PV array Max. power point voltage(34V, 45V)/system voltage(26V)

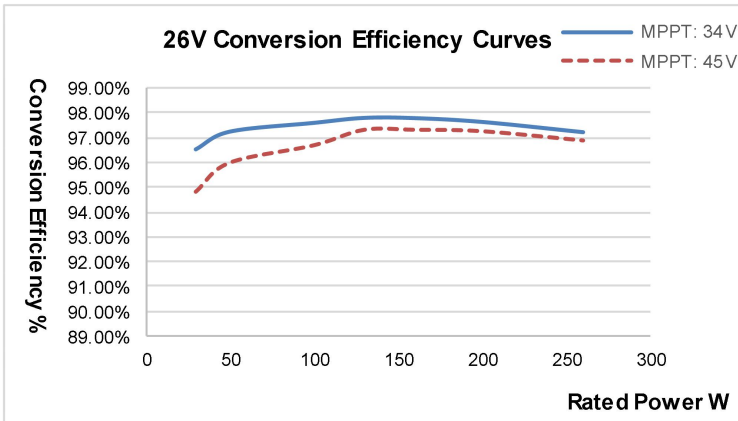

Model: Tracer1210AN G3

1. PV array Max. power point voltage(17V, 34V)/system voltage(13V)

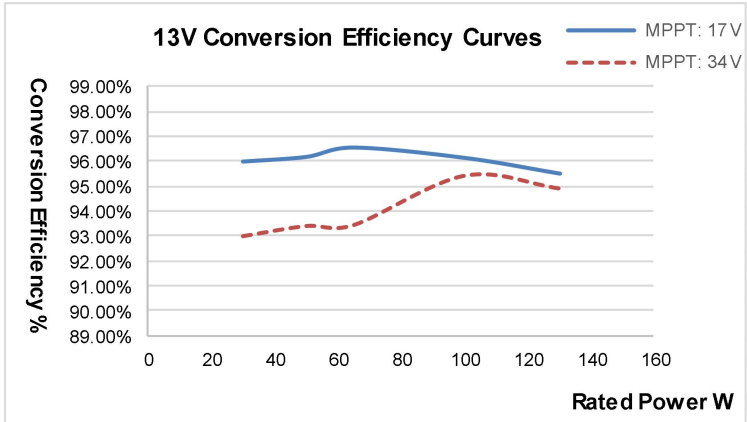

2. PV array Max. power point voltage(34V, 45V)/system voltage(26V)

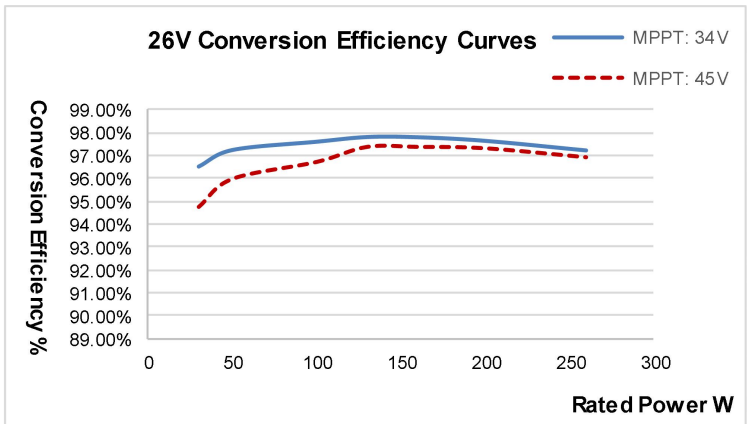

Model: Tracer2206AN G3

1. PV array Max. power point voltage(17V, 34V)/system voltage(13V)

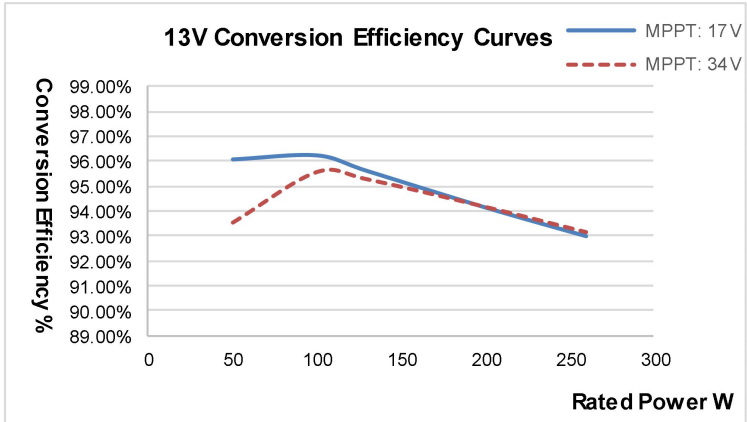

2. PV array Max. power point voltage(34V, 42V)/system voltage(26V)

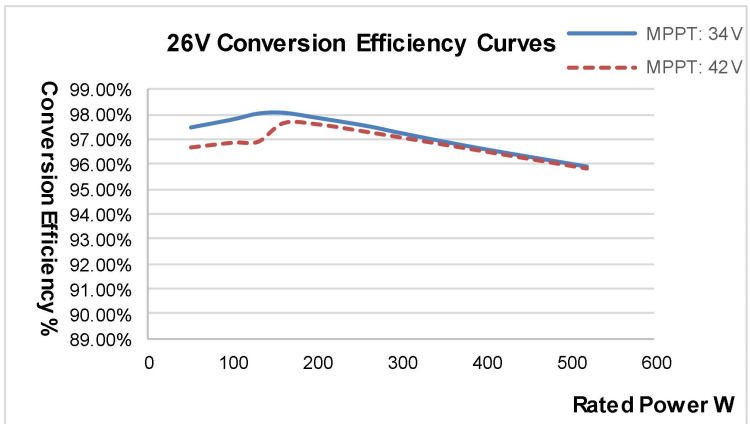



Model: Tracer2210AN G3

1. PV array Max. power point voltage(17V, 34V)/system voltage(13V)

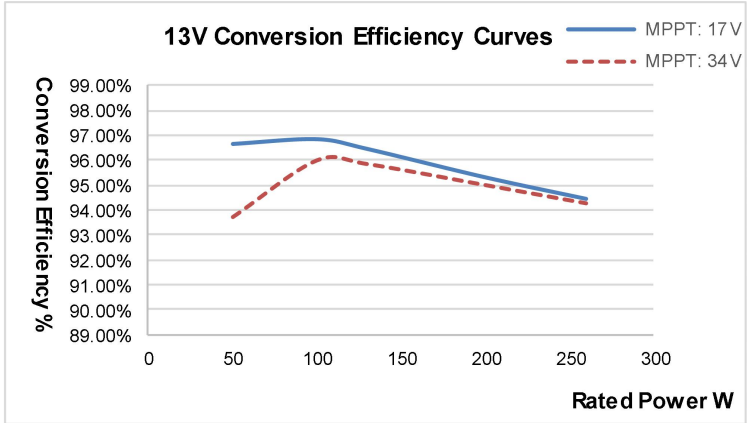

2. PV array Max. power point voltage(34V, 51V, 68V)/system voltage(26V)

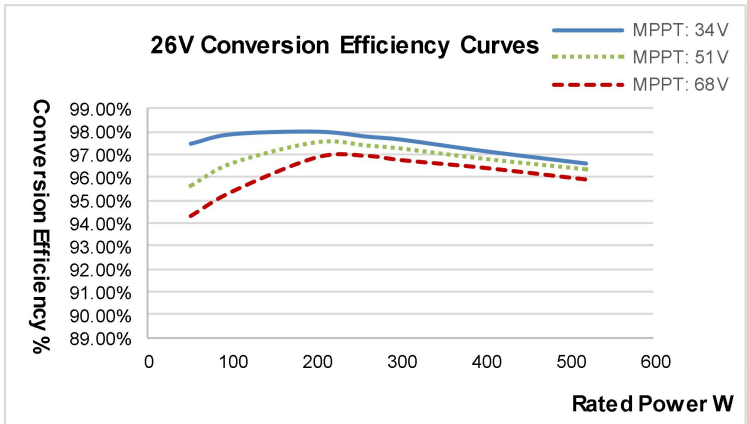

Model: Tracer3210AN G3

1. PV array Max. power point voltage(17V, 34V)/system voltage(13V)

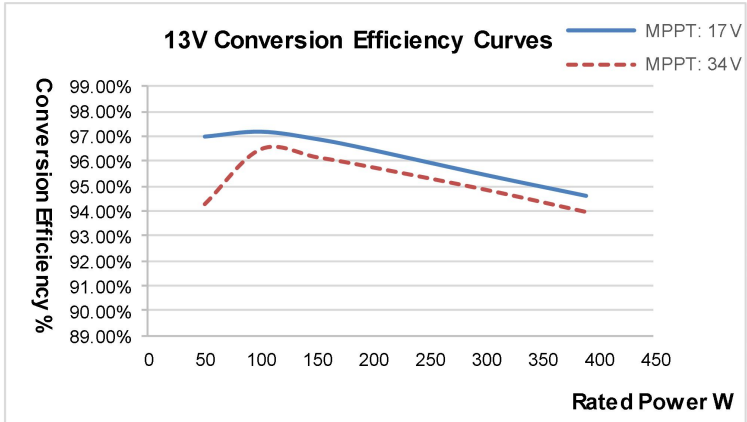

2. PV array Max. power point voltage(34V, 51V, 68V)/system voltage(26V)

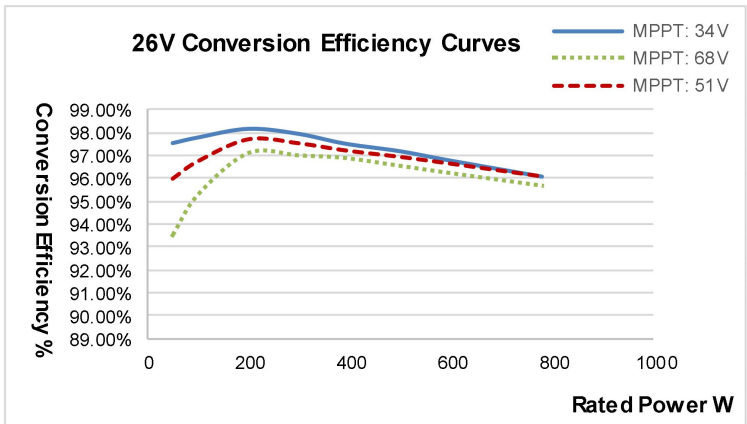

Model: Tracer4210AN G3

1. PV array Max. power point voltage(17V, 34V)/system voltage(13V)

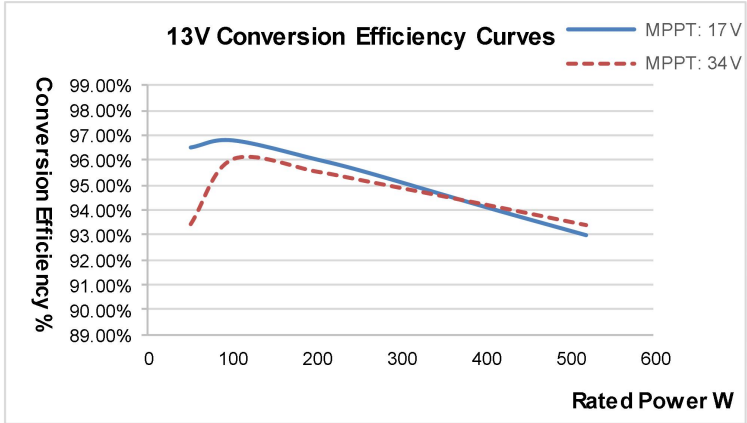

2. PV array Max. power point voltage(34V, 51V, 68V)/system voltage(26V)

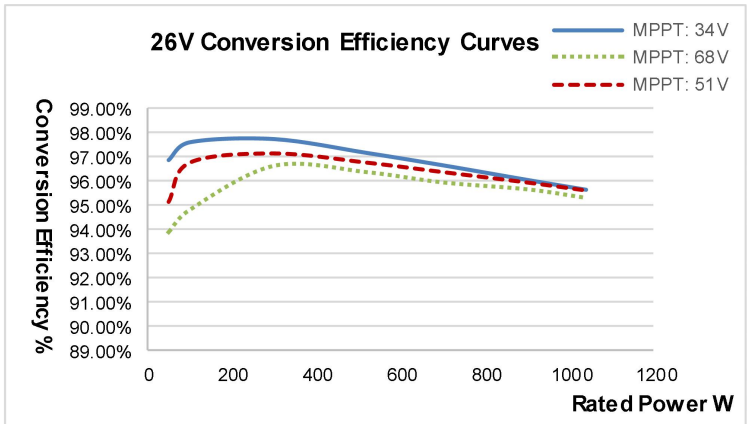

Any changes without prior notice!

Version number: V2.0

**HUIZHOU EPEVER TECHNOLOGY CO., LTD.**

**Tel: +86-752-3889706**

**E-mail: [info@epever.com](mailto:info@epever.com)**

**Website: [www.epever.com](http://www.epever.com)**