

DLC Display Co., Limited

德爾西顯示器有限公司



MODEL No: DLC0283PZG-8

TEL: 86-755-86029824

FAX: 86-755-86029827

E-MAIL: sales@dlcdisplay.com

WEB: www.dlcdisplay.com



Record of Revision

| Date | Revision No. | Summary |
|------------|--------------|--------------------|
| 2016-02-02 | 1.0 | Rev 1.0 was issued |
| | | |
| | | |
| | | |

1. Scope

This data sheet is to introduce the specification of DLC0283PZG-8 active matrix TFT module. It is composed of a color TFT-LCD panel, driver ICs, FPC and a backlight unit. The 2.83" display area contains 240(RGB) x 320 pixels.

2. Application

Digital equipments which need color display, mobile phone, mobile navigator/video systems.

3. General Information

| Item | Contents | Unit |
|-------------------------------|---------------------------------|------|
| Size | 2.83 | inch |
| Resolution | 240(RGB) x 320 | / |
| Interface | CPU / RGB | / |
| Technology type | a-Si | / |
| Pixel Configuration | R.G.B. Vertical Stripe | |
| Outline Dimension (W x H x D) | 50.0 x 69.2 x 2.54 | mm |
| Active Area | 43.2 x 57.6 | mm |
| Display Mode | Transmissive, Normally white | / |
| Backlight Type | LED | / |
| Driver IC | ILI9341V | / |
| Weight | TBD | g |

4. Outline Drawing

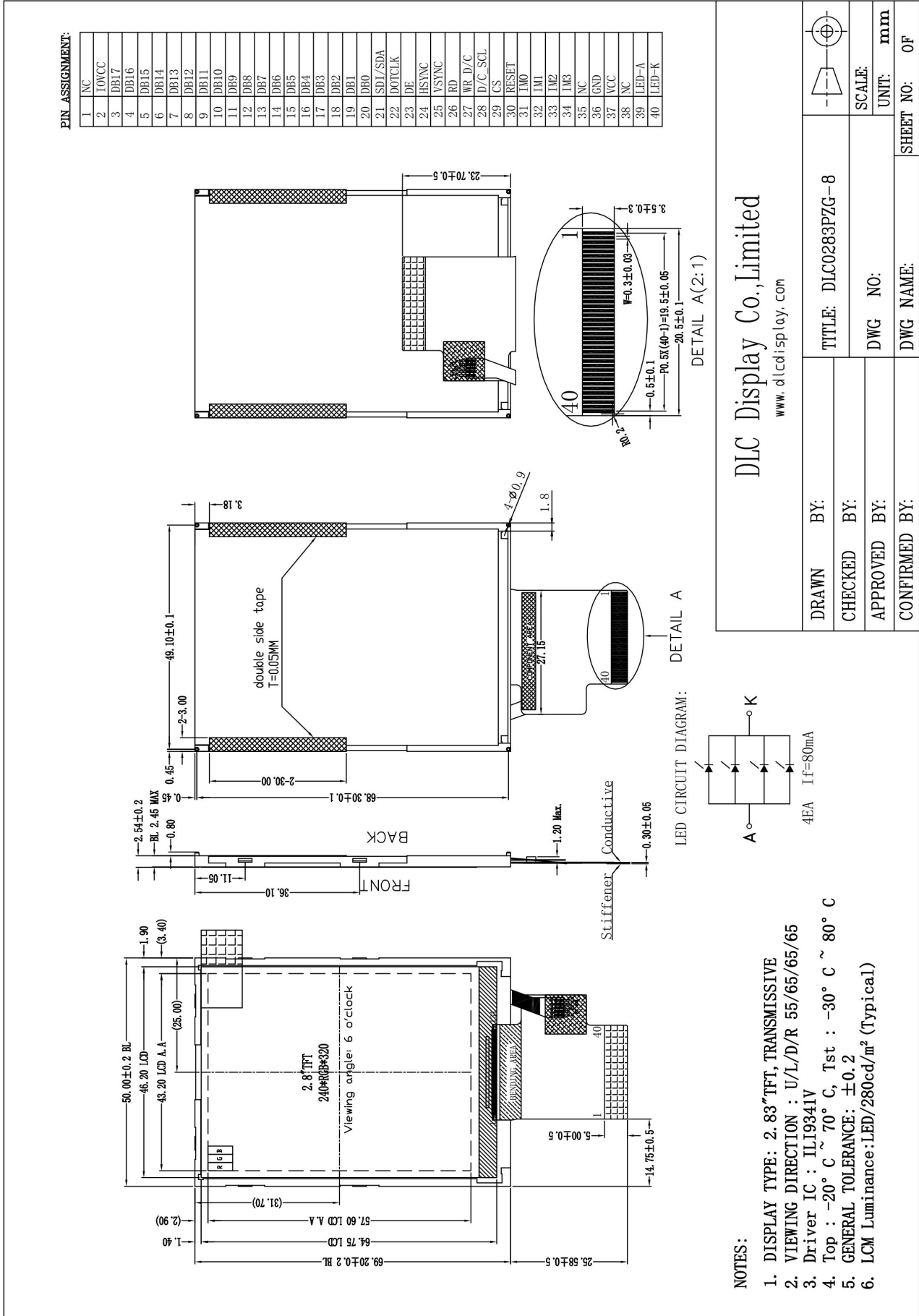

DLC Display Co., Limited

www.dlcdisplay.com

| | | |
|---------------|---------------------|----------|
| DRAWN BY: | TITLE: DLC0283PZG-8 | |
| CHECKED BY: | DWG NO: | SCALE: |
| APPROVED BY: | DWG NAME: | UNIT: mm |
| CONFIRMED BY: | SHEET NO: | OF |

5. Interface signals

| Pin No. | Symbol | I/O | Function |
|---------|----------|-----|---|
| 1 | NC | - | No connection |
| 2 | IOVCC | P | Digital I/O power supply |
| 3-20 | DB17-DB0 | I | Data bus |
| 21 | SDI/SDA | I | Serial Input / Output pin |
| 22 | DOTCLK | I | Data clock signal for RGB interface |
| 23 | DE | I | Data enable signal for RGB interface |
| 24 | HSYNC | I | Line sync signal for RGB interface |
| 25 | VSYNC | I | Frame sync signal for RGB interface |
| 26 | RD | I | Read enable pin in parallel interface |
| 27 | WR_D/C | I | WR: Write enable pin in parallel interface D/C: The selector of command or parameter in parallel interface |
| 28 | D/C_SCL | I | D/C: The selector of command or parameter in parallel interface SCL: Serial data clock in serial interface |
| 29 | CS | I | Chip select signal |
| 30 | RESET | I | System Reset |
| 31-34 | IM0-IM3 | I | System interface select |
| 35 | NC | - | No connection |
| 36 | GND | P | Ground |
| 37 | VCC | P | Power supply |
| 38 | NC | - | No connection |
| 39 | LED-A | P | LED back light(Anode) |
| 40 | LED-K | P | LED back light(Cathode) |

| IM3 | IM2 | IM1 | IM0 | Interface | DB Pin in use | |
|-----|-----|-----|-----|--------------------------------------|------------------|-------------------|
| | | | | | Register/Content | GRAM |
| 0 | 0 | 0 | 0 | 80 MCU 8-bit bus interface I | DB[7:0] | DB[7:0] |
| 0 | 0 | 0 | 1 | 80 MCU 16-bit bus interface I | DB[7:0] | DB[15:0] |
| 0 | 0 | 1 | 0 | 80 MCU 9-bit bus interface I | DB[7:0] | DB[8:0] |
| 0 | 0 | 1 | 1 | 80 MCU 18-bit bus interface I | DB[7:0] | DB[17:0] |
| 0 | 1 | 0 | 1 | 3-line 9-bit data serial interface I | SDA: In/Out | |
| 0 | 1 | 1 | 0 | 4-line 8-bit data serial interface I | SDA: In/Out | |
| 1 | 0 | 0 | 0 | 80 MCU 16-bit bus interface II | DB[8:1] | DB[17:10] DB[8:1] |
| 1 | 0 | 0 | 1 | 80 MCU 8-bit bus interface II | DB[17:10] | DB[17:10] |
| 1 | 0 | 1 | 0 | 80 MCU 18-bit bus interface II | DB[8:1] | DB[17:0] |
| 1 | 0 | 1 | 1 | 80 MCU 9-bit bus interface II | DB[17:10] | DB[17:9] |

6. Absolute maximum Ratings

6.1. Electrical Absolute max. ratings

| Parameter | Symbol | MIN | MAX | Unit | Remark |
|-------------------------|--------|------|-----|------|--------|
| Power Supply for Analog | VCC | -0.3 | 4.6 | V | |
| Power supply for Logic | IOVCC | -0.3 | 4.6 | V | |

Notes:

1. If the module is above these absolute maximum ratings. It may become permanently damaged. Using the module within the following electrical characteristic conditions are also exceeded, the module will malfunction and cause poor reliability.
2. $V_{CC} > V_{SS}$ must be maintained.

6.2. Environment Conditions

| Item | Symbol | MIN | MAX | Unit | Remark |
|-----------------------|--------|-----|-----|------|--------|
| Operating Temperature | TOPR | -20 | 70 | °C | |
| Storage Temperature | TSTG | -30 | 80 | °C | |

Note:

1. The response time will become lower when operated at low temperature.
2. Background color changes slightly depending on ambient temperature.
The phenomenon is reversible.
3. $T_a \leq 40^\circ\text{C}$: 85%RH MAX.
 $T_a > 40^\circ\text{C}$: Absolute humidity must be lower than the humidity of 85%RH at 40°C .

7. Electrical Specifications

7.1 Electrical characteristics

GND=0V, Ta=25°C

| Parameter | Symbol | Condition | Min | Typ | Max | Unit | Note | |
|-------------------------|------------------|-----------------|-----------------------|---------------------|-----|---------------------|------|--|
| Power supply for Analog | VCC | Ta=25°C | 2.5 | 2.8 | 3.3 | V | | |
| Power supply for Logic | IOVCC | Ta=25°C | 1.65 | 2.8 | 3.3 | V | | |
| Input voltage | 'H' | V _{IH} | V _{CC} =2.8V | 0.7*V _{CC} | - | V _{CC} | V | |
| | 'L' | V _{IL} | V _{CC} =2.8V | 0 | - | 0.3*V _{CC} | V | |
| Current Consumption | I _{CC1} | Normal mode | - | 8 | 15 | mA | 1 | |
| | I _{CC2} | Sleep mode | - | 0.05 | 0.1 | mA | 1 | |

Note: Tested in 1×1 chessboard pattern.

7.2 LED Backlight

Ta=25°C

| Item | Symbol | Condition | Min | Typ | Max | Unit | Note |
|----------------|----------------|------------------------|-----|-----|-----|-------------------|------|
| Supply voltage | V _f | I _f =20x4mA | - | 3.0 | - | V | |
| Uniformity | Δ Bp | I _f =20x4mA | 80 | | | % | |
| Luminance | L _v | I _f =20x4mA | - | 280 | | cd/m ² | |

Note: LED power consumption is around 0.132W.

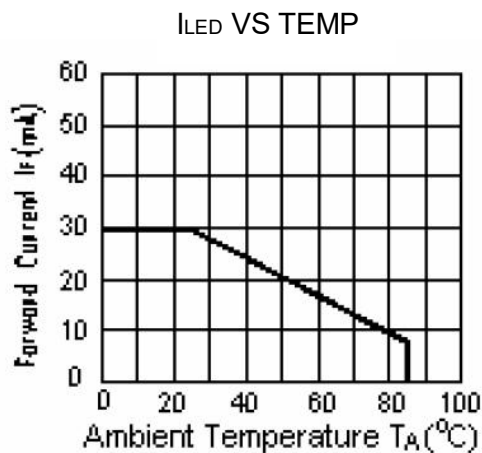

8. Command/AC Timing

8.1 CPU Interface Timing

| Signal | Symbol | Parameter | Min | Max | Unit |
|--|--------|-----------------------------------|-----|-----|------|
| RS | tast | Address setup time | 0 | - | ns |
| | taht | Address hold time(Write/Read) | 10 | - | ns |
| CS | tcs | Chip Select setup time(Write) | 15 | - | ns |
| | trcs | Chip Select setup time(Read) | 45 | - | ns |
| | tcsf | Chip Select Wait time(Write/Read) | 10 | - | ns |
| WR | twc | Write cycle | 66 | - | ns |
| | twrh | Write Control pulse H duration | 15 | - | ns |
| | twrl | Write Control pulse L duration | 15 | - | ns |
| RD | trc | Read cycle | 160 | - | ns |
| | trdh | Read Control pulse H duration | 90 | - | ns |
| | trdl | Read Control pulse L duration | 45 | - | ns |
| DB[17:0] DB[15:0] DB[8:0] DB[7:0] | twds | Write data setup time | 10 | - | ns |
| | twdh | Write data hold time | 10 | - | ns |
| | tracc | Read access time | - | 340 | ns |
| | trod | Read output disable time | 20 | 80 | ns |

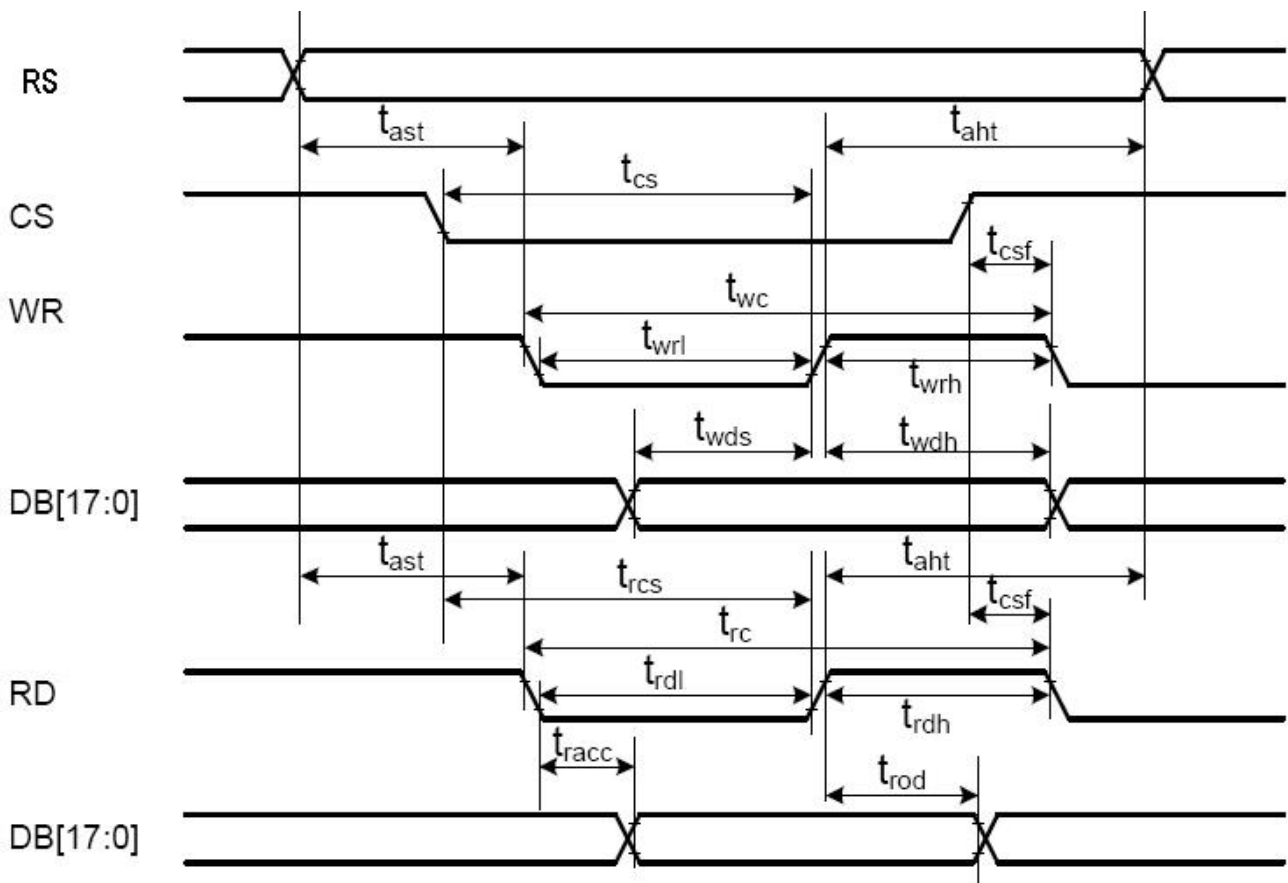

8.2 Reset Timing Characteristics

| Item | Symbol | Min. | Typ. | Max. | Unit |
|------------------------|--------|------|------|------|------|
| RESET low-level width | tRES | 1 | - | - | ms |
| RESET rise time | trRES | - | - | 10 | s |
| Reset high-level width | tRES_H | 50 | | | ms |

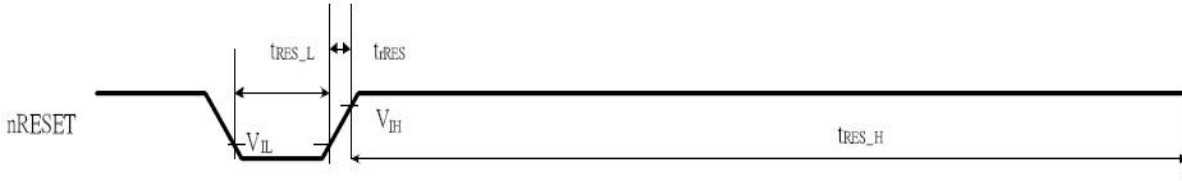

8.3 Power ON/Off Sequence

Power on

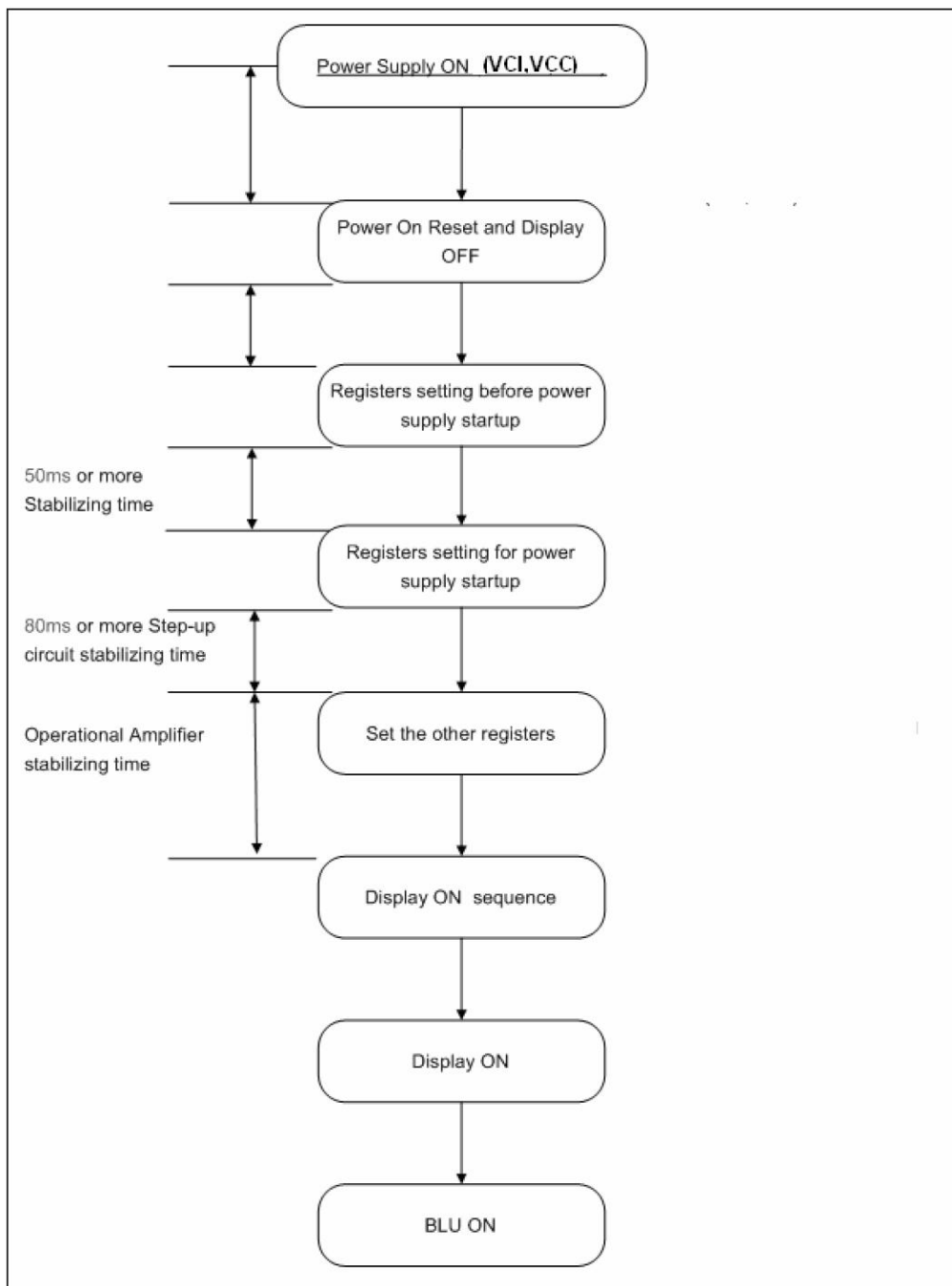

Power off

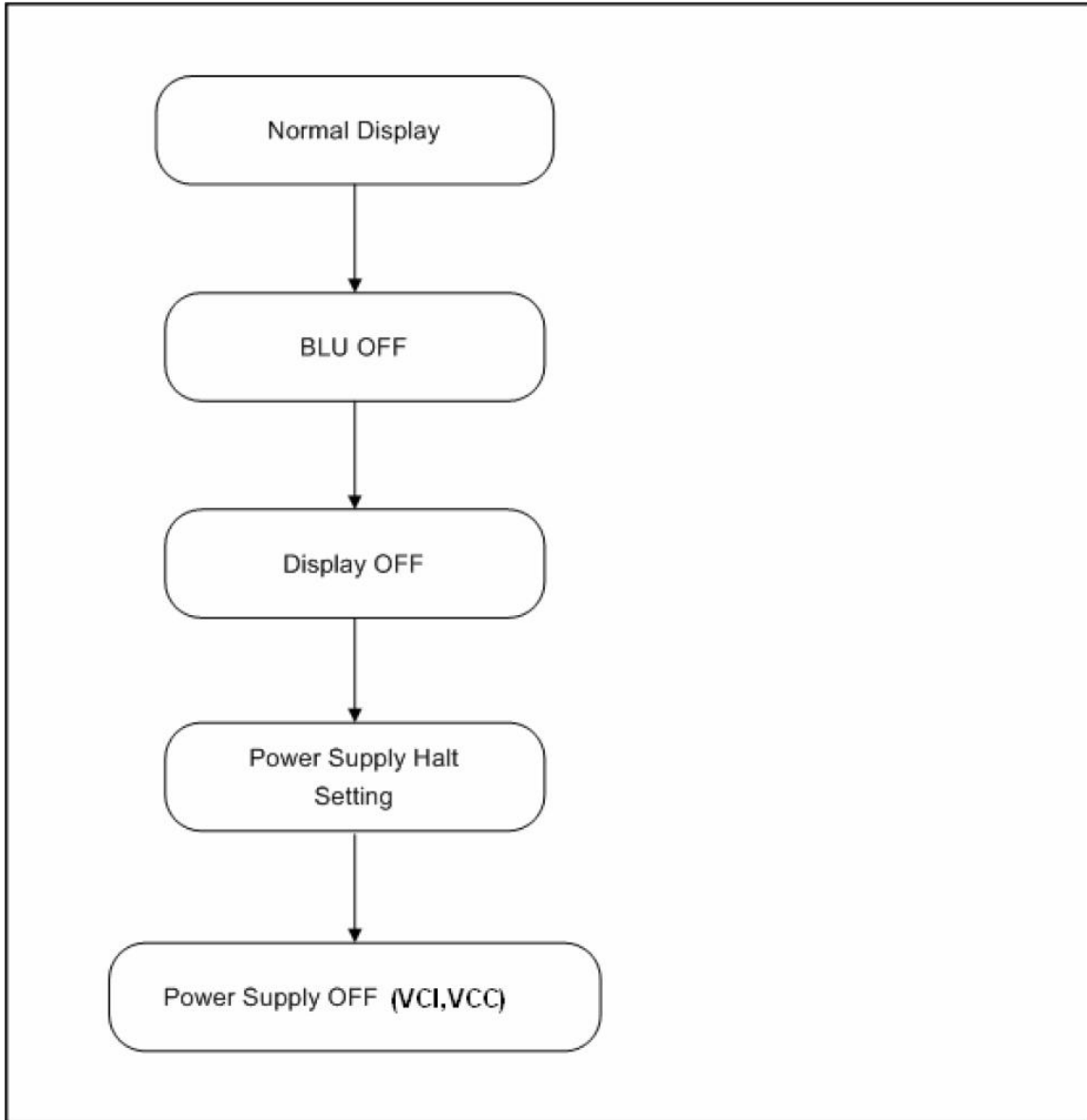

9. Optical Specification

Ta=25°C

| Item | Symbol | Condition | Min | Typ. | Max. | Unit | Remark |
|----------------|------------|---------------------|-----|------|------|-------------------|----------------|
| Contrast Ratio | CR | $\theta=0^\circ$ | 300 | 500 | - | | Note1 Note2 |
| Response Time | Tr | 25°C | - | 10 | - | ms | Note1 |
| | Tf | | - | 10 | - | ms | Note3 |
| View Angles | θT | $CR \geq 10$ | - | 55 | - | Degree | Note 4 |
| | θB | | - | 65 | - | | |
| | θL | | - | 65 | - | | |
| | θR | | - | 65 | - | | |
| Chromaticity | White | Brightness is on | x | 0.28 | - | Note5, Note1 | |
| | | | y | 0.33 | - | | |
| | Red | | x | 0.51 | - | | |
| | | | y | 0.34 | - | | |
| | Green | | x | 0.31 | - | | |
| | | | y | 0.56 | - | | |
| | Blue | | x | 0.15 | - | | |
| | | | y | 0.14 | - | | |
| NTSC | S | | 50 | 60 | -- | % | Note5 |
| Luminance | L | | -- | 280 | -- | cd/m ² | Note1 Note6 |
| Uniformity | U | | -- | 80 | -- | % | Note1 Note7 |

Note 1: Definition of optical measurement system.

Temperature = 25°C(±3°C); LED back-light: ON, Environment brightness < 150 lx

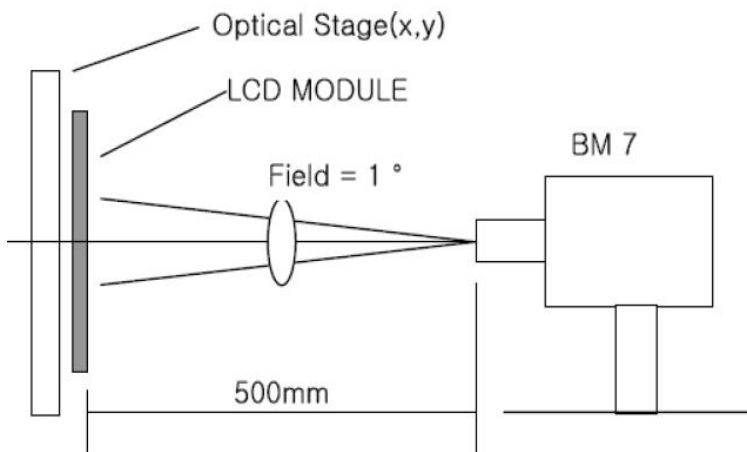

Note 2: Contrast ratio is defined as follow:

$$\text{Contrast Ratio} = \frac{\text{Surface Luminance with all white pixels}}{\text{Surface Luminance with all black pixels}}$$

Note 3: Response time is defined as follow:

Response time is the time required for the display to transition from black to white (Rise Time, T_r) and from white to black(Decay Time, T_f).

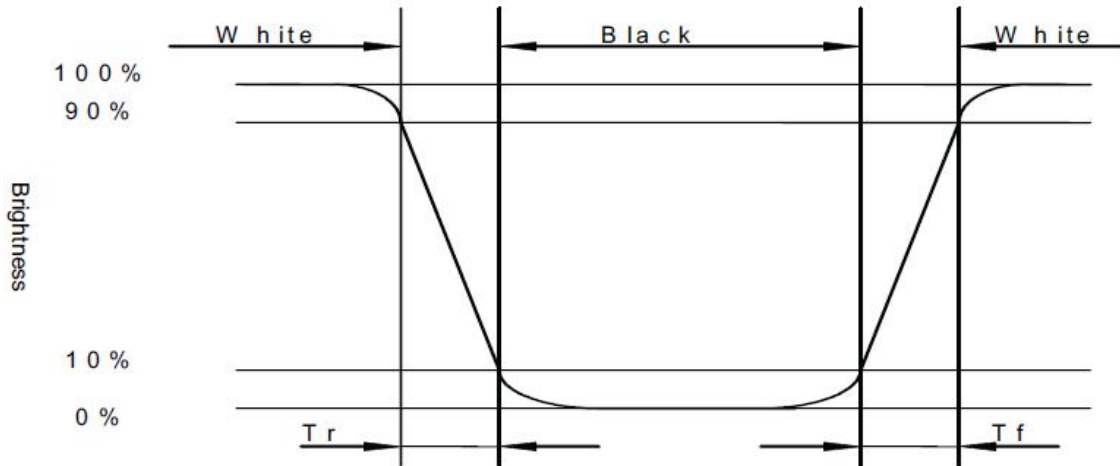

Note 4: Viewing angle range is defined as follow:

Viewing angle is measured at the center point of the LCD.

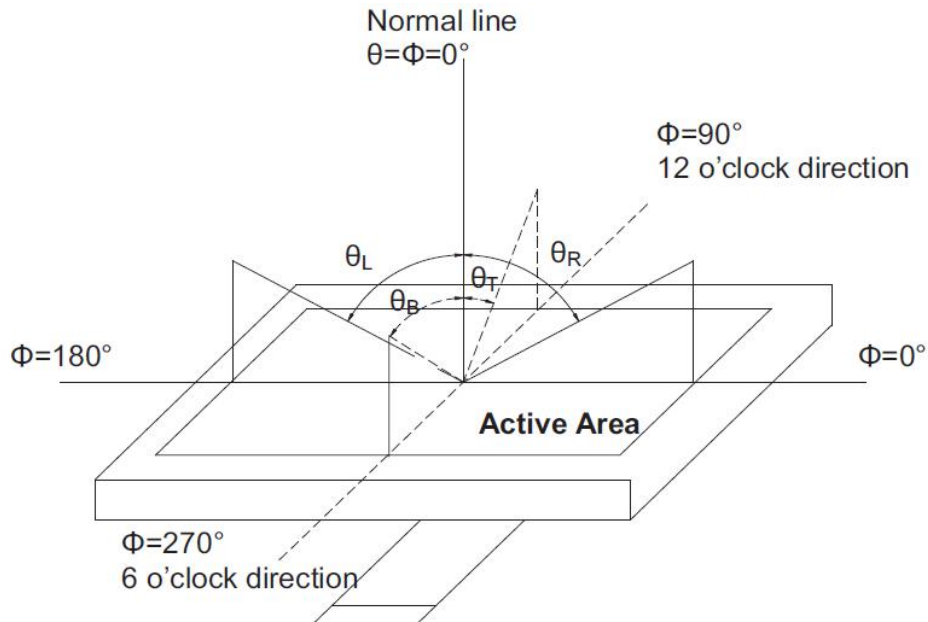

Note 5: Color chromaticity is defined as follow: (CIE1931)

Color coordinates measured at center point of LCD.

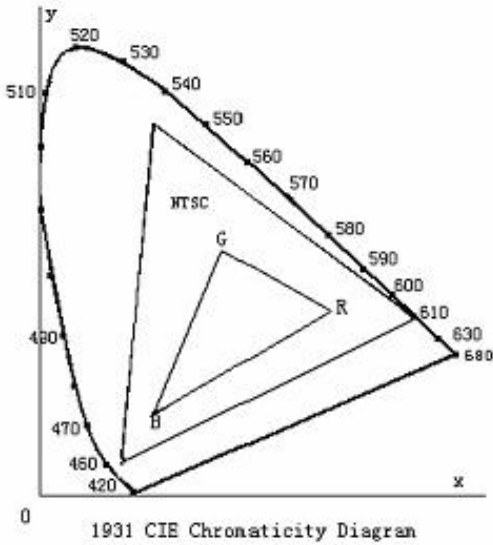

$$S = \frac{\text{area of RGB triangle}}{\text{area of NTSC triangle}} \times 100\%$$

Note 6: Luminance is defined as follow:

Luminance is defined as the brightness of all pixels “White” at the center of display area on optimum contrast.

Note 7: Luminance Uniformity is defined as follow:

Active area is divided into 9 measuring areas (Refer Fig. 2). Every measuring point is placed at the center of each measuring area.

$$\text{Uniformity (U)} = \frac{\text{Minimum Luminance(brightness) in 9 points}}{\text{Maximum Luminance(brightness) in 9 points}}$$

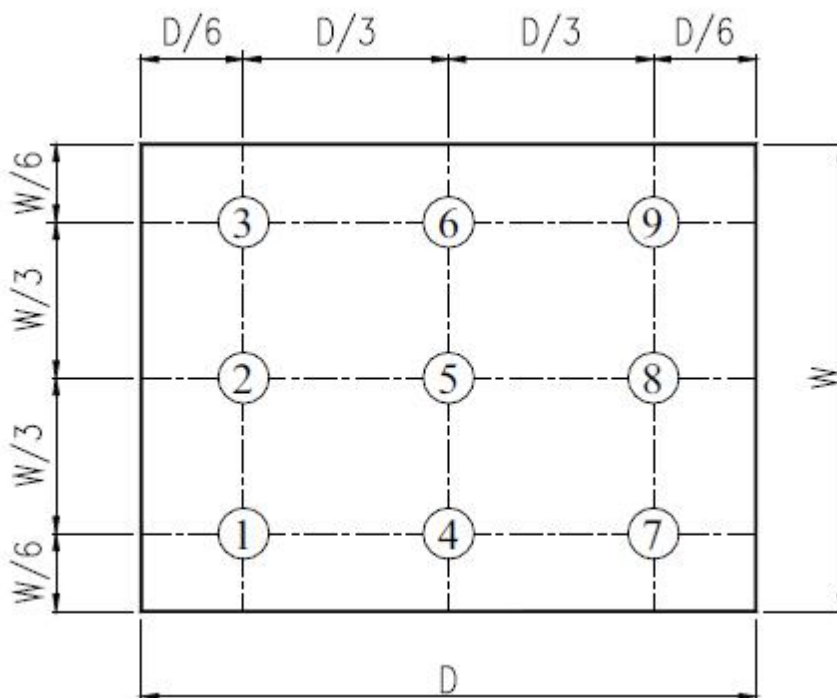

Fig. 2 Definition of uniformity

10. Environmental / Reliability Tests

| No | Test Item | Condition | Judgment criteria |
|----|-----------------------------------|---|---|
| 1 | High Temp Operation | Ts=+70°C, 96hrs | Per table in below |
| 2 | Low Temp Operation | Ta=-20°C, 96hrs | Per table in below |
| 3 | High Temp Storage | Ta=+80°C, 96hrs | Per table in below |
| 4 | Low Temp Storage | Ta=-30°C, 96hrs | Per table in below |
| 5 | High Temp & High Humidity Storage | Ta=+40°C, 90% RH 96 hours | Per table in below (polarizer discoloration is excluded) |
| 6 | Thermal Shock (Non-operation) | -30°C 30 min~+80°C 30 min, Change time:5min, 5 Cycles | Per table in below |
| 7 | ESD (Operation) | C=150pF, R=330Ω, 5points/panel Air:±8KV, 5times; Contact:±4KV, 5 times; | Per table in below |
| 8 | Vibration (Non-operation) | 10Hz~150Hz, 100m/s ² , 120min | Per table in below |
| 9 | Shock (Non-operation) | Half- sine wave,300m/s ² ,11ms | Per table in below |
| 10 | Package Drop Test | Height:80 cm, 1 corner, 3 edges, 6 surfaces | Per table in below |

| INSPECTION | CRITERION(after test) |
|------------------------|---|
| Appearance | No Crack on the FPC, on the LCD Panel |
| Alignment of LCD Panel | No Bubbles in the LCD Panel No other Defects of Alignment in Active area |
| Electrical current | Within device specifications |
| Function / Display | No Broken Circuit, No Short Circuit or No Black line No Other Defects of Display |

11. Precautions for Use of LCD Modules

10.1 Safety

The liquid crystal in the LCD is poisonous. Do not put it in your mouth. If the liquid crystal touches your skin or clothes, wash it off immediately using soap and water.

10.2 Handling

A. The LCD and touch panel is made of plate glass. Do not subject the panel to mechanical shock or to excessive force on its surface.

B. Do not handle the product by holding the flexible pattern portion in order to assure the reliability

C. Transparency is an important factor for the touch panel. Please wear clear finger sacks, gloves and mask to protect the touch panel from finger print or stain and also hold the portion outside the view area when handling the touch panel.

D. Provide a space so that the panel does not come into contact with other components.

E. To protect the product from external force, put a covering lens (acrylic board or similar board) and keep an appropriate gap between them.

F. Transparent electrodes may be disconnected if the panel is used under environmental conditions where dew condensation occurs.

G. Property of semiconductor devices may be affected when they are exposed to light, possibly resulting in IC malfunctions.

H. To prevent such IC malfunctions, your design and mounting layout shall be done in the way that the IC is not exposed to light in actual use.

10.3 Static Electricity

A. Ground soldering iron tips, tools and testers when they are in operation.

B. Ground your body when handling the products.

C. Power on the LCD module before applying the voltage to the input terminals.

D. Do not apply voltage which exceeds the absolute maximum rating.

E. Store the products in an anti-electrostatic bag or container.

10.4 Storage

A. Store the products in a dark place at $+25^{\circ}\text{C} \pm 10^{\circ}\text{C}$ with low humidity (40% RH to 60% RH). Don't expose to sunlight or fluorescent light.

B. Storage in a clean environment, free from dust, active gas, and solvent.

10.5 Cleaning

A. Do not wipe the touch panel with dry cloth, as it may cause scratch.

B. Wipe off the stain on the product by using soft cloth moistened with ethanol. Do not allow ethanol to get in between the upper film and the bottom glass. It may cause peeling issue or defective operation. Do not use any organic solvent or detergent other than ethanol.

10.6 Cautions for installing and assembling

Bezel edge must be positioned in the area between the Active area and View area. The bezel may press the touch screen and cause activation if the edge touches the active area.

A gap of approximately 0.5mm is needed between the bezel and the top electrode. It may cause unexpected activation if the gap is too narrow. There is a tolerance of 0.2 to 0.3mm for the outside dimensions of the touch panel and tail. A gap must be made to absorb the tolerance in the case and connector.

