

F

E

D

C

B

A

ZONE	SYMBOL	REVISION	APPROVAL	DATE
		ADD MATE PLUG	J.X.KUANG	20-9-2006

RoHS
Compliant

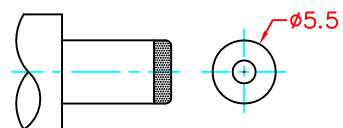
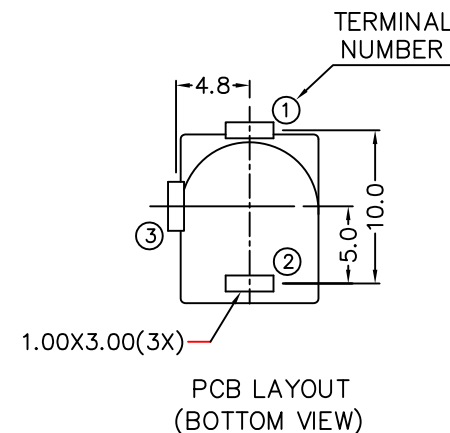
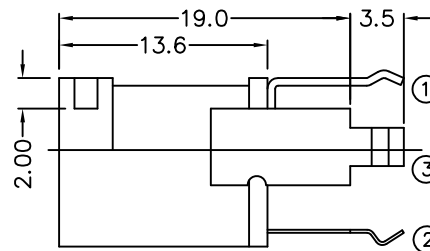
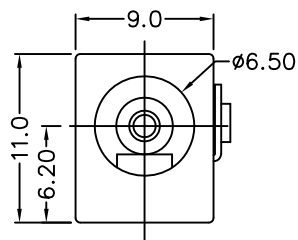
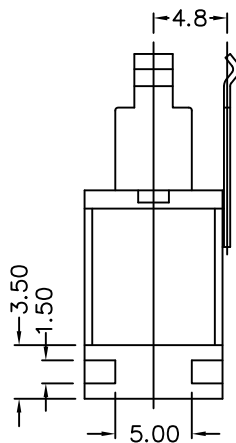
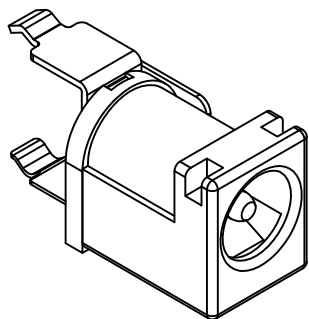

DC MATE PLUG

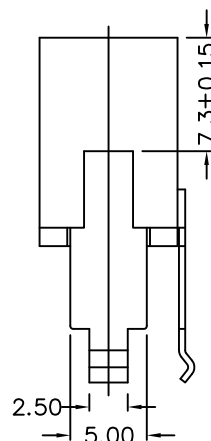

MODEL NO.	DJ-006H
SCHEMATIC	
CENTER PIN	$\phi 2\text{mm}$
	$\phi 2.5\text{mm}$

*** MATERIAL**

CENTRE PIN : COPPER
 TERMINAL 1 : BRASS
 TERMINAL 2 : COPPER ALLOY
 TERMINAL 3 : BRASS
 HOUSING : PBT
 COVER : PBT

ACCURATE INNOTECH INC.

DESIGN		J.JIANG	DATE	4-6-2004	SCALE	2:1
DRAWING		L.L.ZHANG	DATE	20-9-2006	MATERIAL	*
PART NAME	HIGH CURRENT DC POWER JACK	TOLERANCE UNLESS	0.0±0.2	CHECK	DATE	DWG. NO. TZ\DJ006H-PBT/B
PART NO.	DJ-006H	OTHERWISE SPECIFIED:	0.00±0.1 0.000±0.05	APPROVAL	DATE	SHEET

F

E

D

C

B

A

DCF-04/A