

HFD23

SUBMINIATURE SIGNAL RELAY



File No.:E133481



File No.:R50306254



File No.:CQC09002035070

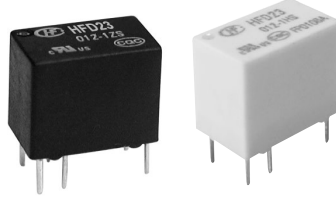

Features

- Max.4A switching capability
- High sensitive: 150mW
- 1 Form C configuration
- Gold plated contact
- Subminiature
- Plastic sealed type available
- 90°C high temperature specific for selection

RoHS compliant

CONTACT DATA

Contact arrangement	1A	1C
Contact resistance	100mΩ max. (at 10mA 30mVDC)	
Contact material	AgNi +Au plated	
Contact rating (Res. load)	1A 125VAC/2A 30VDC	0.5A 125VAC/1A 30VDC
Max. switching voltage	125VAC / 60VDC	
Max. switching current	4A	2A
Max. switching power	125VA / 60W	62.5VA / 30W
Min. applicable load ¹⁾	1mA 5V	
Mechanical endurance	1 x 10 ⁷ OPS	
Electrical endurance ²⁾	9 x 10 ⁴ OPS (1H:1A 125VAC; 1Z:0.5A 125VAC, Resistive load., Room temp., 1s on 9s off)	

Notes: 1) Min. applicable load is reference value. Please perform the confirmation test with the actual load before production since reference value may change according to switching frequencies, environmental conditions and expected contact resistance and reliability.

2) Electric endurance data are collected in the NO or NC contact test.

CHARACTERISTICS

Insulation resistance	1000MΩ (at 500VDC)	
Dielectric strength	Between coil & contacts	1000VAC 1min
	Between open contacts	500VAC 1min
Operate time (at rated. volt.)	5ms max.	
Release time (at rated. volt.)	5ms max.	
Temperature rise (at rated.volt.)	65K max.	
Vibration resistance	10Hz to 55Hz 3.3mm DA	
Shock resistance	Functional	196m/s ²
	Destructive	980m/s ²
Humidity	5% to 98% RH	
Ambient temperature	-40°C to 85°C	
	-40°C to 90°C(high temperature)	
Unit weight	Approx. 2.2g	
Termination	PCB (DIP)	
Construction	Plastic sealed	

Notes: 1) The data shown above are initial values.

2) UL insulation system: Class A

COIL

Coil power	Sensitive: Approx. 150mW; Standard: Approx. 200mW
------------	--

COIL DATA

at 23°C

Standard type

Nominal Voltage VDC ¹⁾	Initial Pick-up Voltage VDC max. ¹⁾	Initial Drop-out Voltage VDC min.	Max. Voltage VDC ⁴⁾	Coil Resistance Ω
1.5	1.13	0.15	3.0	11.3 x (1±10%)
2.4	1.80	0.24	4.8	28.8 x (1±10%)
3	2.25	0.30	6.0	45 x (1±10%)
4.5	3.38	0.45	9.0	101.3 x (1±10%)
5	3.75	0.50	10	125 x (1±10%)
6	4.50	0.60	12	180 x (1±10%)
9	6.75	0.90	18	405 x (1±10%)
12	9.00	1.20	24	720 x (1±10%)
24	18.00	2.40	48	2880 x (1±15%)

Sensitive type

Nominal Voltage VDC ¹⁾	Initial Pick-up Voltage VDC max. ¹⁾	Initial Drop-out Voltage VDC min.	Max. Voltage VDC ⁴⁾	Coil Resistance Ω
1.5	1.13	0.15	3.0	15 x (1±10%)
2.4	1.80	0.24	4.8	38.4 x (1±10%)
3	2.25	0.30	6.0	60 x (1±10%)
4.5	3.38	0.45	9.0	135 x (1±10%)
5	3.75	0.50	10	167 x (1±10%)
6	4.50	0.60	12	240 x (1±10%)
9	6.75	0.90	18	540 x (1±10%)
12	9.00	1.20	24	960 x (1±10%)
24	18.00	2.40	48	3840 x (1±15%)



HONGFA RELAY

ISO9001, IATF16949, ISO14001, ISO45001, IECQ QC 080000, ISO/IEC 27001 CERTIFIED

2023 Rev. 1.00

COIL DATA

at 23°C

Notes:1) The data shown above are initial values.

2) To supply rated step voltage to coil is the foundation of relay proper operation. Please make sure the applied voltage to the coil reach at rated values.

Please refer to the typical diagram below for single side stable relay. The "V_{coil}" is the rated voltage:

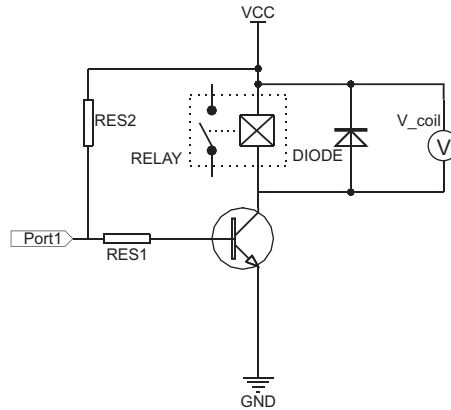

3) In case 5V of transistor drive circuit, it is recommended to use 4.5V type relay, and 3V to use 2.4V type relay.

4) For monostable relays, if you need to drop down voltage and hold mode after reliably operating, make sure that the effective value of holding voltage is not less than 60% of the rated voltage.

5) Maximum voltage refers to the maximum voltage which relay coil could endure in a short period of time.

6) When user's requirements can't be found in the above table, special order allowed.

7) During the relay pick-up or drop-out processes, there are stages of contact pressure change, contact vibration and unstable contact etc.

When the voltage applied to coil is gradually changed, it will lengthen the unstable stage and affect relay endurance. To reduce this influence, please apply step voltage (switching circuit) to relay coil.

SAFETY APPROVAL RATINGS

UL/CUL	1H type:	1Z type:
	2A 30VDC 40 °C 1A 125VAC 40 °C 1A 30VDC 90 °C 0.5A 125VAC 90 °C	1A 30VDC 85 °C 0.5A 48VDC 70 °C 0.5A 125VAC 85 °C 1A 30VDC 90 °C 0.5A 125VAC 90 °C

Notes: 1) All values unspecified are at room temperature.

2) Only typical loads are listed above. Other load specifications can be available upon request.

ORDERING INFORMATION

Type	HFD23 / 012 -1Z S (XXX)				
Coil voltage	1.5, 2.4, 3, 4.5, 5, 6, 9, 12, 24VDC				
Contact arrangement	1H: 1 Form A 1Z: 1 Form C				
Coil power	S: Sensitive type P: Standard type				
Special code ²⁾	XXX: Customer special requirement Nil: Standard 866: High temperature type				

Notes: 1) Contact is recommended for suitable condition and specifications if water cleaning or surface process is involved in assembling relays on PCB.

2) The customer special requirement express as special code after evaluating by Hongfa.

3) The high temperature type indicates the maximum ambient temperature 90°C and the high temperature type is 866. It is only suitable for sensitive specifications.

4) Standard tube packing length is 265mm. Any special requirement needed, please contact us for more details.

5) For products that should meet the explosion-proof requirements of "IEC 60079 series", please note [Ex] after the specification while placing orders. Not all products have explosion-proof certification, so please contact us if necessary, in order to select the suitable products.

OUTLINE DIMENSIONS, WIRING DIAGRAM AND PC BOARD LAYOUT

Unit: mm

Outline Dimensions

Wiring Diagram (Bottom view)

PCB Layout (Bottom view)

HFD23/1Z type

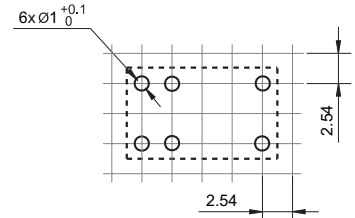
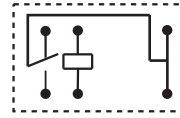
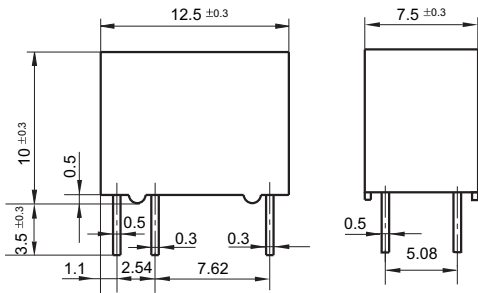

HFD23/1H type

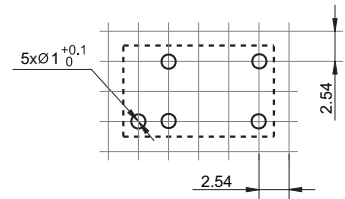
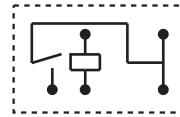
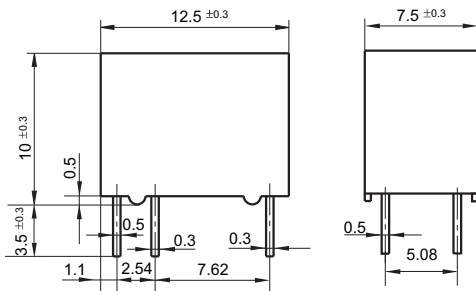

- Remark: 1) The pin dimension of the product outline drawing is the size before tinning (it will become larger after tinning), and the mounting hole size is the recommended design size of the PCB board hole. The specific PCB board hole design size can be mapped and adjusted according to the actual product.
- 2) In case of no tolerance shown in outline dimension: outline dimension ≤ 1 mm, tolerance should be ± 0.2 mm; outline dimension > 1 mm and ≤ 5 mm, tolerance should be ± 0.3 mm; outline dimension > 5 mm, tolerance should be ± 0.4 mm.
- 3) The tolerance without indicating for PCB layout is always ± 0.1 mm.
- 4) The width of the gridding is 2.54mm.
- 5) 1C type has six Terminals, 1A type has five Terminals.

CHARACTERISTIC CURVES

MAXIMUM SWITCHING POWER

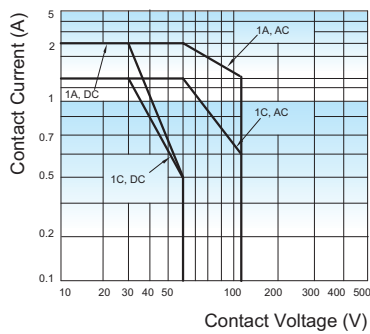

ENDURANCE CURVE

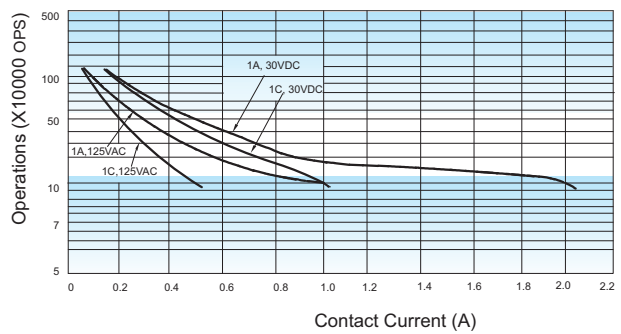

Test conditions:

Resistive load, Room temp., 1s on 9s off.

CHARACTERISTIC CURVES

Notice

- 1) To avoid using relays under strong magnetic field which will change the parameters of relays such as pick-up voltage and drop-out voltage.
- 2) Energizing coil with rated voltage is basic for normal operation of a relay, please make sure the energized voltage to relay coil have reached the rated voltage. Regarding latching relay, in order to maintain the "set" or "reset" status, impulse width of the rated voltage applied to coil should be more than 5 times of "set" or "reset" time.
- 3) For a monosteady state relay, after the relay is reliably operated, if it needs to be kept under pressure, make sure that the effective value of the voltage is not less than 60 % of the rated voltage;
- 4) The relay may be damaged because of falling or when shocking conditions exceed the requirement.
- 5) Please use wave soldering or manual soldering for straight-in relay. If you need reflow welding, please confirm the feasibility with us.
- 6) Contact is recommended for suitable condition and specifications if water cleaning or surface process is involved in assembling relays on PCB.
- 7) Regarding the plastic sealed relay, we should leave it cooling naturally until below 40°C after welding, then clean it and deal with coating, remarkably the temperature of solvents should also be controlled below 40°C. Please avoid cleaning the relay by ultrasonic, avoid using the solvents like gasoline, Freon, and so on, which would affect the configuration of relay or influence the environment.
- 8) When applied with continuous current, the heat from relay coil will age its isolation. Thus, please do not ground connected the coil to reduce electrical erosion if possible. And please provide protection circuit to avoid broken wire and losses.
- 9) Please make sure that there are no silicon-based substances (such as silicon rubber, silicone oil, silicon-based coating agents, silicon fillers, etc.) around the relay, because it will generate silicon-containing volatile gas, which may cause poor contact in case of silicon-containing volatile gas sticking on contact
- 10) About preferable condition of operation, storage and transportation, please refer to "Explanation to terminology and guidelines of relay".
- 11) During the relay pick-up or drop-out processes, there are stages of contact pressure change, contact vibration and unstable contact etc. When the voltage applied to coil is gradually changed, it will lengthen the unstable stage and affect relay endurance. To reduce this influence, please apply step voltage (switching circuit) to relay coil.

Disclaimer

The specification is for reference only. See to "Terminology and Guidelines" for more information. Specifications subject to change without notice. We could not evaluate all the performance and all the parameters for every possible application. Thus the user should be in a right position to choose the suitable product for their own application. If there is any query, please contact Hongfa for the technical service. However, it is the user's responsibility to determine which product should be used only.

© Xiamen Hongfa Electroacoustic Co., Ltd. All rights of Hongfa are reserved.