



LIGITEK ELECTRONICS CO.,LTD.
Property of Ligitek Only

SURFACE MOUNT LED TAPE AND REEL



Lead-Free Parts

LDGM9553-A03

DATA SHEET

DOC. NO : QW0905-LDGM9553-A03

REV. : B

DATE : 14 - Nov. - 2014



Features:

1. Top view LED.
2. white SMT package.
3. Leadframe package with individual 2 pin.
4. Wide viewing angle.
5. Soldering methods: IR reflow soldering.
6. Feature of the device: more light due to higher optical efficiency; extremely wide viewing angle; ideal for backlighting and coupling in light guide.

Descriptions:

The LDGM9553 SMD has wide viewing angle and optimized light coupling by inter reflector, The low current requirement makes this device ideal for portable equipment or any other application where power is at a premium.

Applications:

1. Telecommunication: indicator and backlighting in telephone and fax.
2. Indicators.
3. Switch lights.

Device Selection Guide:

PART NO	MATERIAL	COLOR	
		Emitted	Lens
LDGM9553-A03	InGaN	Green	Water Clear

Package Dimensions

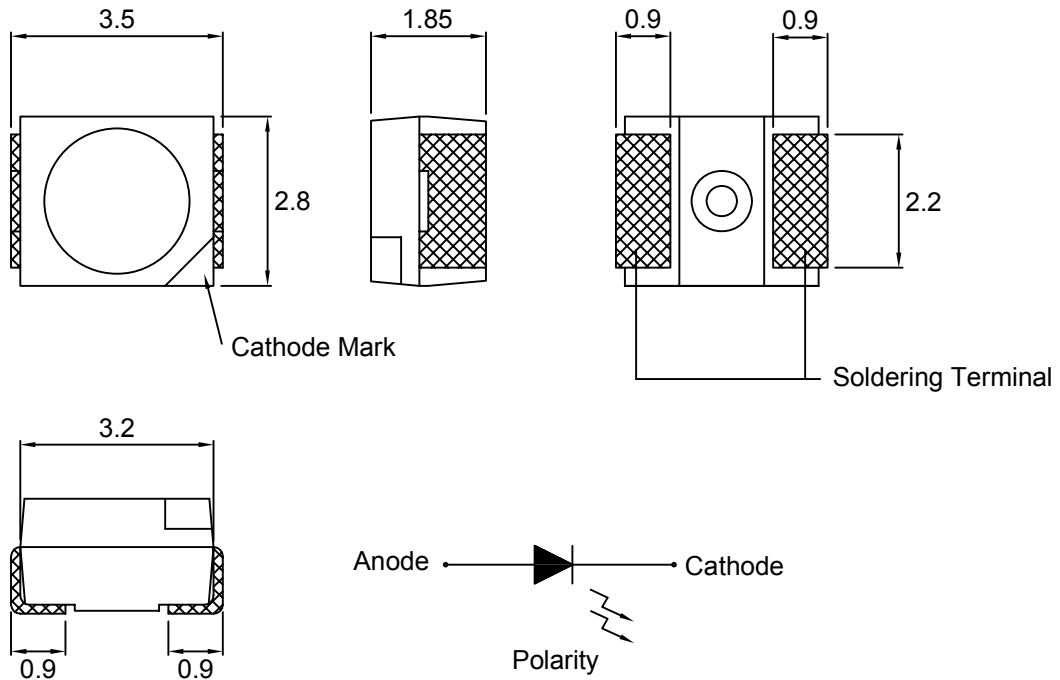

Note : 1.All dimension are in millimeter tolerance is $\pm 0.2\text{mm}$ unless otherwise noted.
 2.Specifications are subject to change without notice.

Recommended Soldering Pad Dimensions

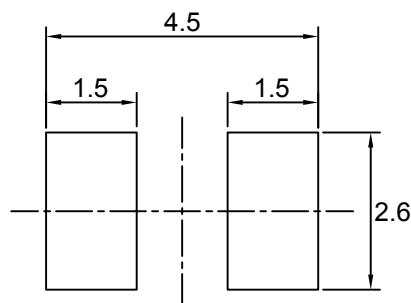

Note : The tolerances unless mentioned is $\pm 0.1\text{mm}$, Angle ± 0.5 . Unit=mm.

Absolute Maximum Ratings at Ta=25 °C

Parameter	Symbol	Ratings	UNIT
		DGM	
Forward Current	IF	30	mA
Peak Forward Current Duty 1/14@10KHz	IFP	100	mA
Power Dissipation	PD	108	mW
Reverse Current @5V	Ir	50	μA
Electrostatic Discharge	ESD	500	V
Operating Temperature	Topr	- 20 ~ + 80	°C
Storage Temperature	Tstg	- 30 ~ + 100	°C

Typical Electrical & Optical Characteristics (Ta=25 °C)

Items	Symbol	Min.	Typ.	Max.	UNIT	CONDITION
Luminous Intensity	Iv	800	1000	----	mcd	IF=20mA
Dominant Wavelength	λD	522	----	531	nm	IF=20mA
Spectral Line Half-Width	Δλ	----	36	----	nm	IF=20mA
Forward Voltage	V _F	2.8	----	3.6	V	IF=20mA
Viewing Angle	2θ 1/2	----	120	----	deg	IF=20mA

Note : 1.The forward voltage data did not including ±0.1V testing tolerance.
2.The luminous intensity data did not including ±15% testing tolerance.
3.The dominant wavelength data did not including ±1nm testing tolerance

Luminous Intensity Classification

BIN CODE	Iv(mcd) at 20mA	
	Min.	Max.
V11V14	800	1000
V21W11	1000	1200
W12W15	1200	1400
W21W24	1400	1600

Dominant Wavelength Classification

BIN CODE	λD (nm) at 20mA	
	Min.	Max.
1P	522	525
1Q	525	528
1R	528	531

Forward Voltage Classification

BIN CODE	Vf(v) at 20mA	
	Min.	Max.
1	2.8	3.0
2	3.0	3.2
3	3.2	3.4
4	3.4	3.6

Typical Electro-Optical Characteristics Curve

DGM CHIP

Fig.1 Forward current vs. Forward Voltage

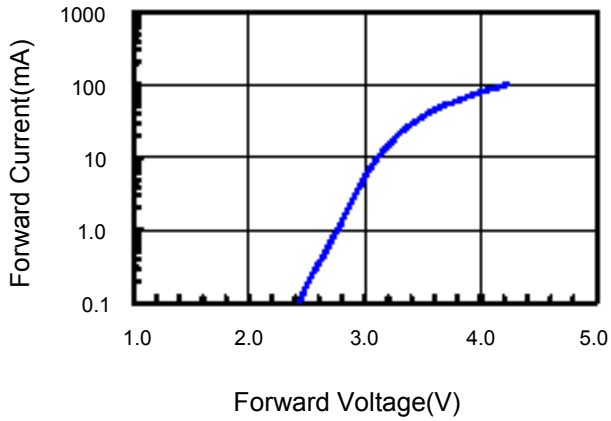

Fig.2 Relative Intensity vs. Forward Current

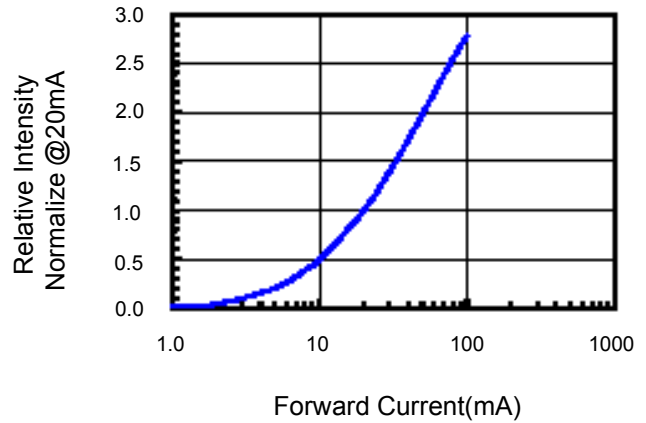

Fig.3 Forward Voltage vs. Temperature

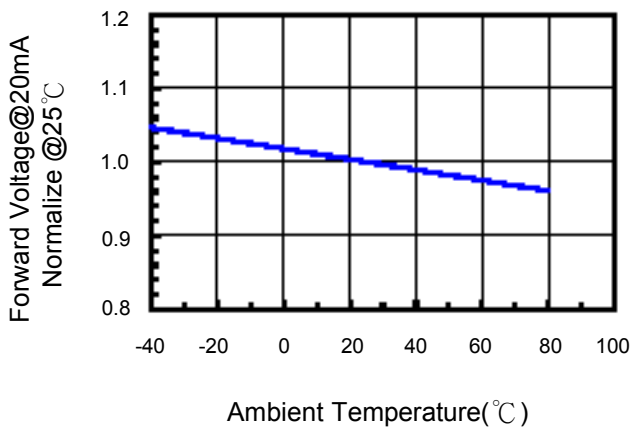

Fig.4 Relative Intensity vs. Temperature

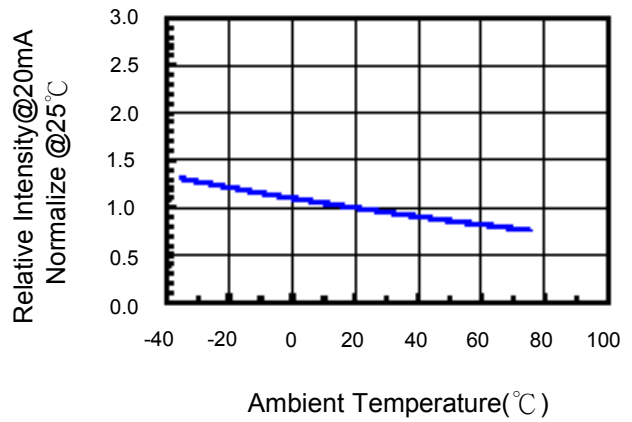

Fig.5 Relative Intensity vs. Wavelength

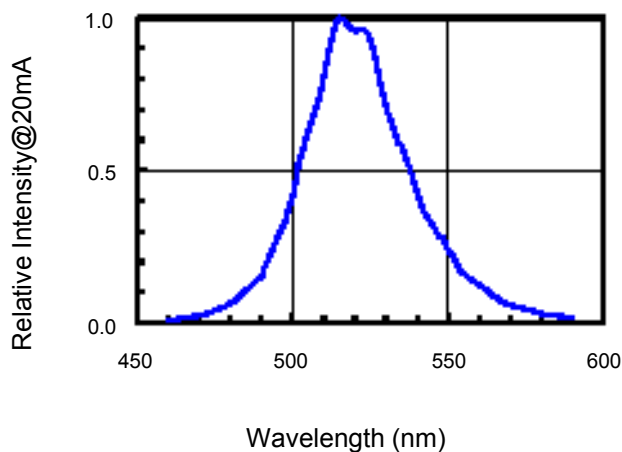
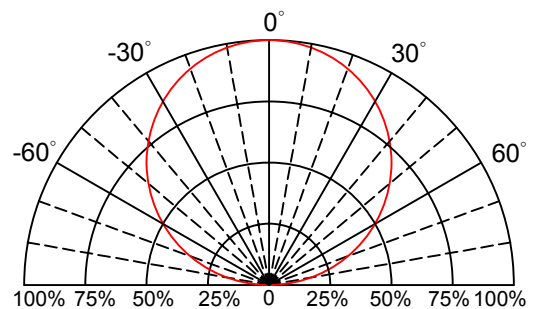



Fig.6 Directive Radiation



Label Explanation

	LIGITEK ELECTRONICS CO., LTD.	
	PART :	LDGM9553-A03
	LOT :	GS11370168
	QTY(PCS):	2000
	BIN/HUE :	W12W15/1Q
	VF:3.0-3.2	

BIN : Luminous Intensity

HUE : Dominant Wavelength

VF : Forward Voltage

Reel Dimensions

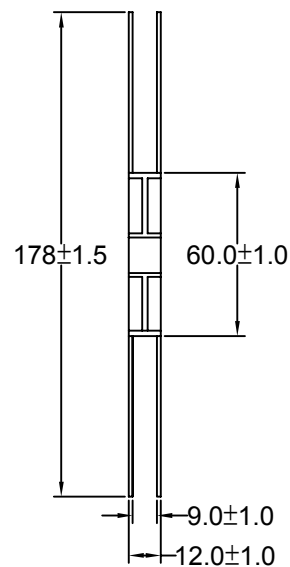
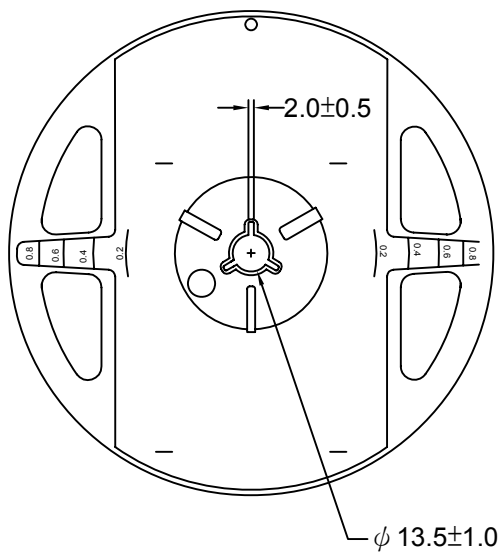

Box Explanation

1. 5 BAG / INNER BOX

2. INNER BOX SIZE : L X W X H 23cm X 8.5cm x 26cm

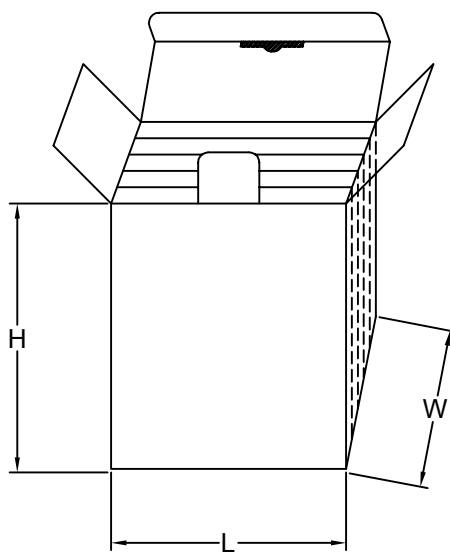

3. 10 INNER BOXES / CARTON

4. CARTON SIZE : L X W X H 58cm X 34cm x 35cm

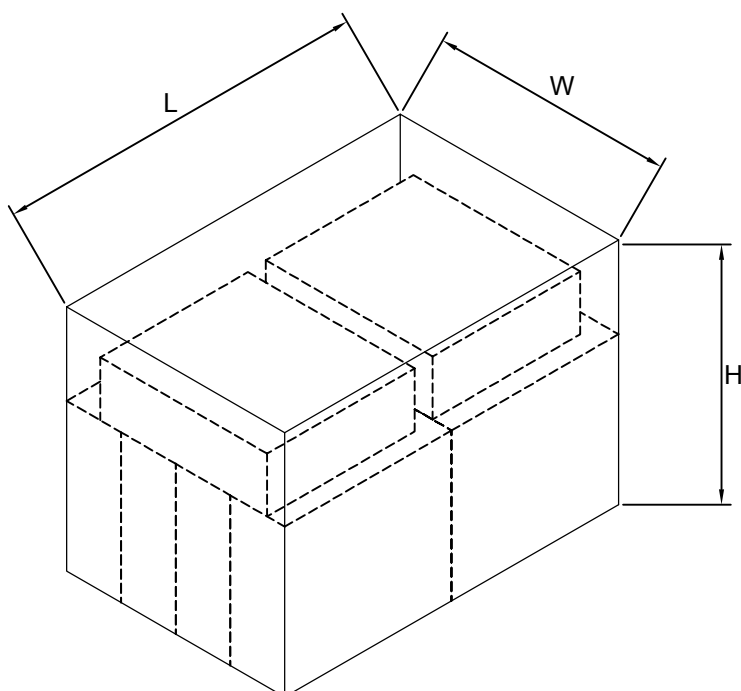

Recommended Soldering Conditions**1. Hand Solder**

Basic spec is $\leq 320^{\circ}\text{C}$ 3 sec one time only.

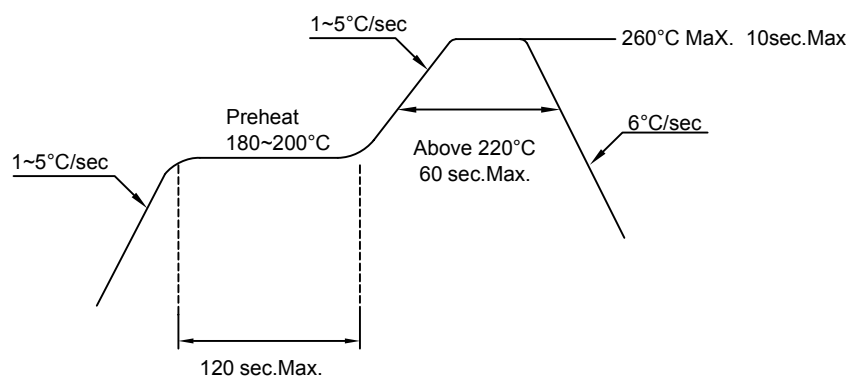
2. PB-Free Reflow Solder**Note:**

- 1.Reflow soldering should not be done more than two times.
- 2.When soldering,do not put stress on the LEDs during heating.
- 3.After soldering,do not warp the circuit board.

Precautions For Use:**Storage time:**

- 1.The operation of Temperatures and RH are : $5^{\circ}\text{C}\sim 35^{\circ}\text{C}$,RH60%.
- 2.Once the package is opened, the products should be used within a week.
Otherwise, they should be kept in a damp proof box with desiccating agent.
Considering the tape life, we suggest our customers to use our products within a year(from production date).
- 3.If opened more than one week in an atmosphere $5^{\circ}\text{C} \sim 35^{\circ}\text{C}$,RH60%, they should be treated at $60^{\circ}\text{C}\pm 5^{\circ}\text{C}$ for 15hrs.

Drive Method:

LED is a current operated device, and therefore, requires some kind of current limiting incorporated into the driver circuit. This current limiting typically takes the form of a current limiting resistor placed in series with the LED.

Consider worst case voltage variations that could occur across the current limiting resistor. The forward current should not be allowed to change by more than 40% of its desired value.

Circuit model A

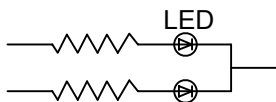

Circuit model B

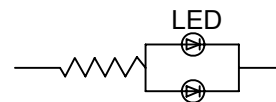

(A) Recommended circuit.

(B) The difference of brightness between LED could be found due to the VF-IF characteristics of LED.

Cleaning:

Use alcohol-based cleaning solvents such as isopropyl alcohol to clean the LED.

ESD(Electrostatic Discharge):

Static Electricity or power surge will damage the LED. Use of a conductive wrist band or anti-electrostatic glove is recommended when handling these LED. All devices, equipment and machinery must be properly grounded.

Reliability Test:

(1)Test items and results

Classification	Test Item	Test Condition	Sample Size
Endurance Test	Operating Life Test	1.Ta=Under Room Temperature As Per Data Sheet Maximum Rating. 2.If=20mA 3.t=1000 hrs	22
	High Temperature Storage Test	1.Ta=105°C±5°C 2.t=500 hrs	22
	Low Temperature Storage Test	1.Ta=-40°C±5°C 2.t=1000 hrs	22
	High Temperature High Humidity Storage Test	1.IR-Reflow In-Board, 2 Times 2.Ta=85°C±5°C 3.RH=90%~95% 4.t=500hrs±2hrs	22
Environmental Test	Thermal Shock Test	1.IR-Reflow In-Board,2 times 2.Ta=105°C ±5°C & -40°C ±5°C (30min) (30min) 3.total 100 cycles	22
	Reflow Soldering Test	1.T.Sol=260°C ±5°C 2.Dwell Time= 10Max.	22
	Temperature Cycling	1.105°C ~ 25°C ~ -40°C 30mins 15mins 30mins 2.100 Cyeles	22

(2)Criteria for judging the damage

Item	Symbol	Test Conditions	Criteria for Judgement	
			Min.	Max.
Forward Voltage	Vf	If=20mA	-	U.S.L x1.2
Reverse Current	Ir	Vr=5V	-	U.S.L x2.0
Luminous Intensity	Iv	If=20mA	L.S.L x 0.5	-

Note:

1.U.S.L.:Upper Standard Level.

2.L.S.L.:Lower Standard Level.