

THIRD ANGLE
PROJECTION

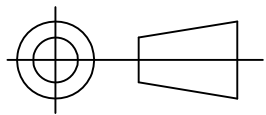

REMOVE ALL BURRS
& SHARP EDGES

△ REVISIONS

DATE

CHANGE P/N/FM 003 TO 007

2003/05/08

08/09/04

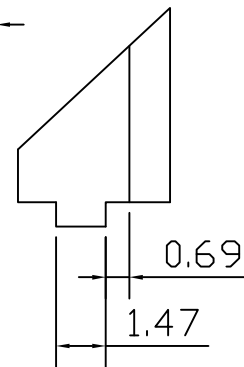
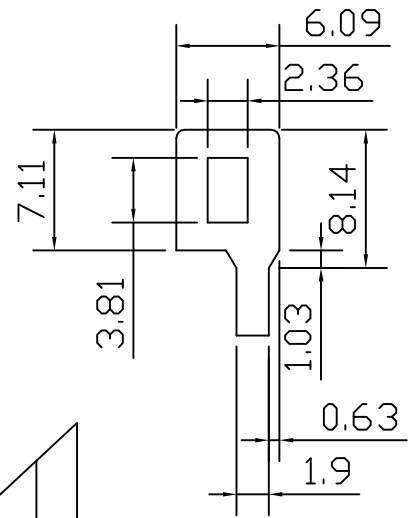
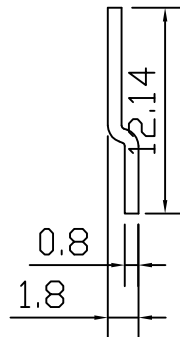
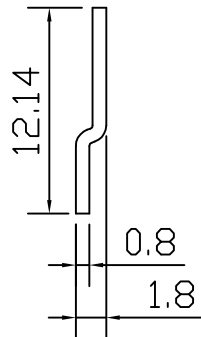
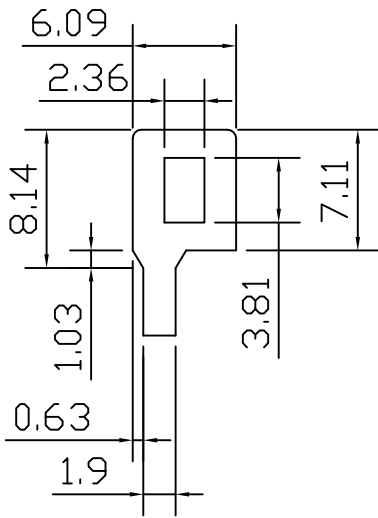
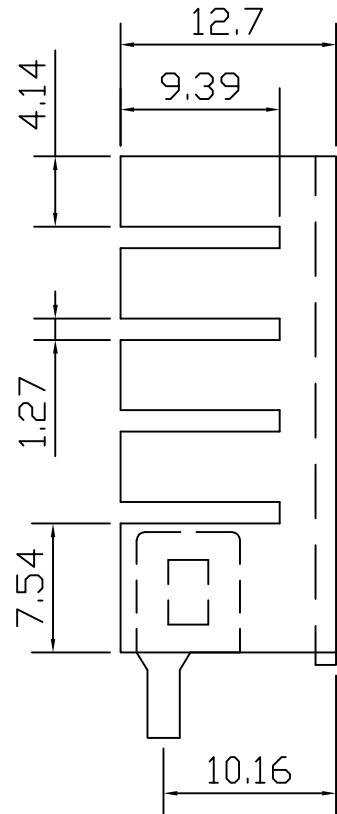
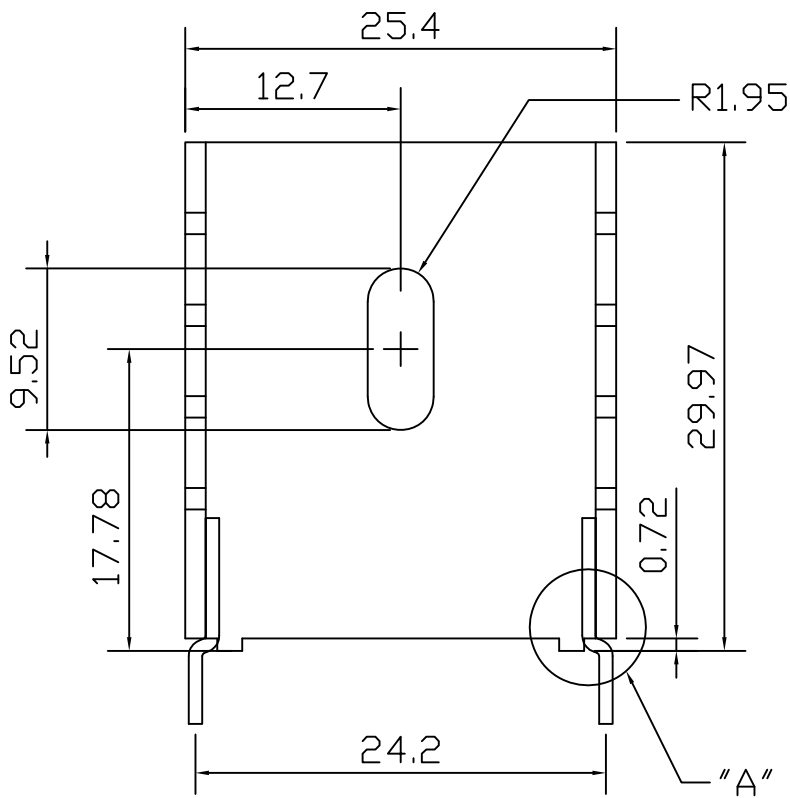

"A" 2:1

BROADLAKE CO., LTD.
P.O.BOX 427 KAOHSIUNG
TEL:886-7-2377661
FAX:886-7-2377667
E-MAIL:Broadlake@broadlake.com.tw

TOLERANCE
UNIT ±0.2

MATERIAL:
AL 1100 T=1.2MM

TITLE:
HEAT SINK

FINISHED: BLACK ANODIZED
PIN:C.R.S. TIN PLATED

PART NO:
BK-T220-0042-007

SCALE:
DIMENSIONS IN M/M

DRAWING NO: